

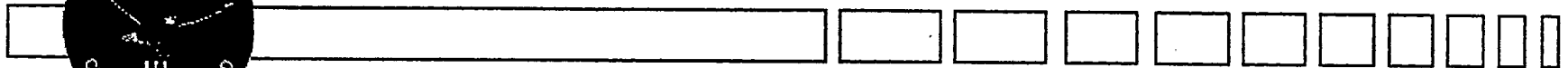

~~TOP SECRET / POLO STEP~~



Compartmented Concept

Update 4 Aug 2002

DECLASSIFIED BY: RADM R.T. Moeller
DECLASSIFY ON: 16 June 2005
ACTION OFFICER: Mr. M.D. Fitzgerald, Civ

~~TOP SECRET / POLO STEP~~

Copy ___ of 8

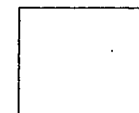

TABL



"Generated Start" Plan

~~TOP SECRET / POLO STEP~~

DECLASSIFIED BY: RADM R.T. Moeller
DECLASSIFY ON: 16 June 2005
ACTION OFFICER: Mr. M.D. Fitzgerald, Civ

Operational Timeline

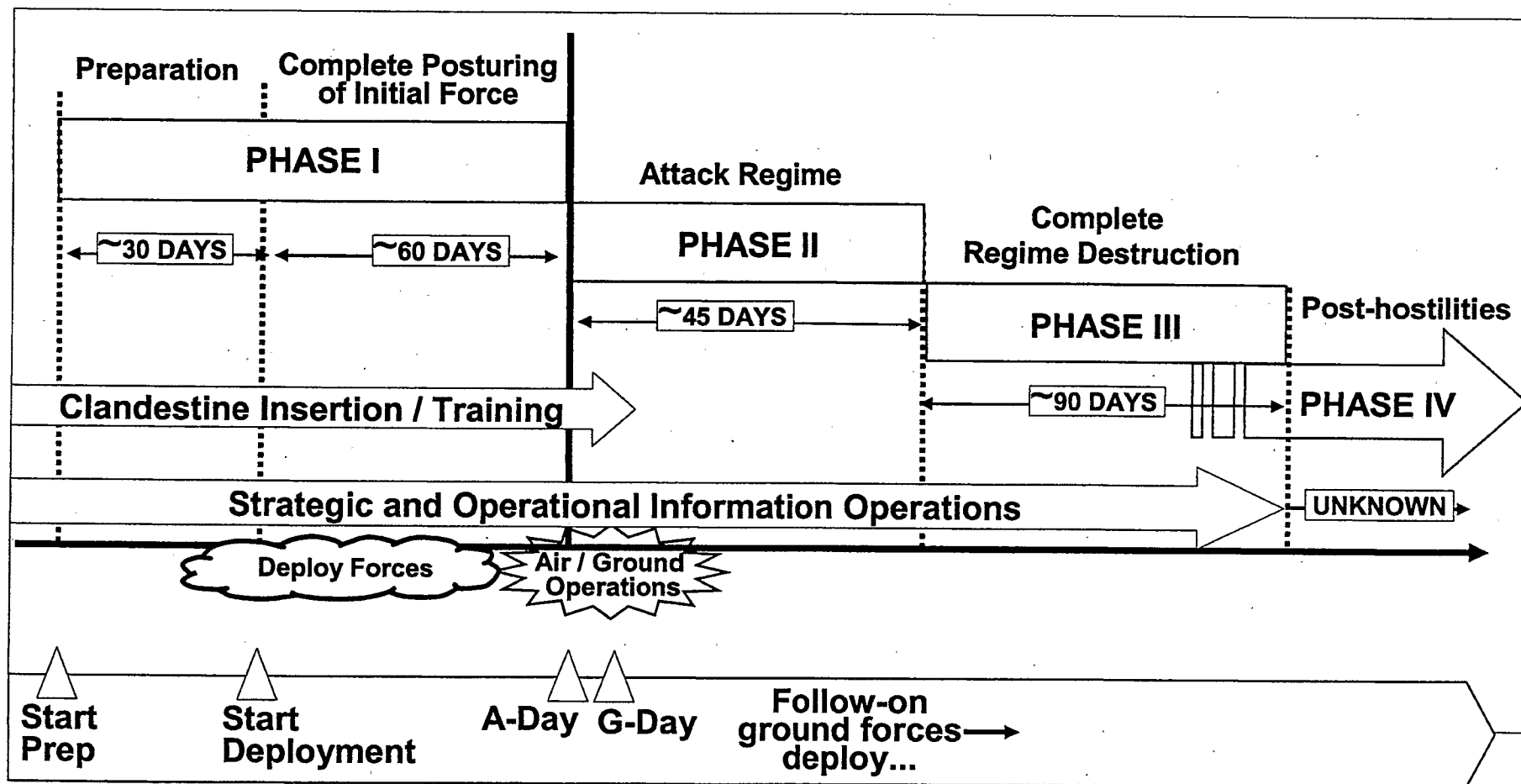

A = Air Operations Begin
G = Ground Operations Begin

~~TOP SECRET / POLO STEP~~



Military Options -- Contingency Responses...

~~TOP SECRET / POLO STEP~~

DECLASSIFIED BY: RADM R.T. Moeller
 DECLASSIFY ON: 16 June 2005
 ACTION OFFICER: Mr. M.D. Fitzgerald, Civ

Response Option(s) 1-5	Small	Medium	Large
<ul style="list-style-type: none"> In Place Forces Existing Bases & Carrier battle group Response is condition-based 1 day duration 	<ul style="list-style-type: none"> In Place Forces Existing Bases, Carrier battle group Response within 4 hours 1-2 day duration 	<ul style="list-style-type: none"> Forces from the continental US (CONUS) Air Wing or a second Carrier battle group Additional Beddown Response within 96 hours 5-7 day duration 	<ul style="list-style-type: none"> CONUS Forces plus an Air Expeditionary Force and a third Carrier battle group Increased Beddown Response within 11 days 14 day duration +...
<p>Effects:</p> <ul style="list-style-type: none"> Destroy active threat systems Targets linked to trigger Hostile Act Hostile Intent 	<p>Effects:</p> <ul style="list-style-type: none"> Degrade enablers Degrade selected capabilities Initial targets linked to trigger 	<p>Effects:</p> <ul style="list-style-type: none"> Defeat enablers Destroy/ degrade selected capabilities Begin to shape battlefield 	<p>Effects:</p> <ul style="list-style-type: none"> Defeat enablers Destroy/degrade multiple capabilities Country-wide effect, all target sets Continue to shape the battlefield
<p>~ 100 Aim Points</p> <p>~ 80 Aircraft Sorties</p>	<p>~ 300 Aim Points</p> <p>~ 90 Aircraft Sorties</p>	<p>~ 1800 Aim Points</p> <p>~ 1000 Aircraft Sorties</p>	<p>~ 3000 Aim Points</p> <p>~ 2100 Aircraft Sorties</p>
<ul style="list-style-type: none"> Southern and Northern Watch One Carrier Battle Group 	<ul style="list-style-type: none"> Southern and Northern Watch One Carrier Battle Group Tactical Land Attack Missile (TLAM) Shooters 	<p>Adds: Global Power / Intel Surveillance and Recon Aircraft / additional Air Wing or Carrier Battle Group / TLAM shooters in Mediterranean</p>	<p>Adds: Global Power / Intel Surveillance and Recon Aircraft / an additional 1-2 Carrier Battle Group(s) / an Air Expeditionary Force</p>

~~TOP SECRET / POLO STEP~~



"Running Start" Plan

~~TOP SECRET / POLO STEP~~

DECLASSIFIED BY: RADM R.T. Moeller
DECLASSIFY ON: 16 June 2005
ACTION OFFICER: Mr. M.D. Fitzgerald, Civ

Operational Timeline

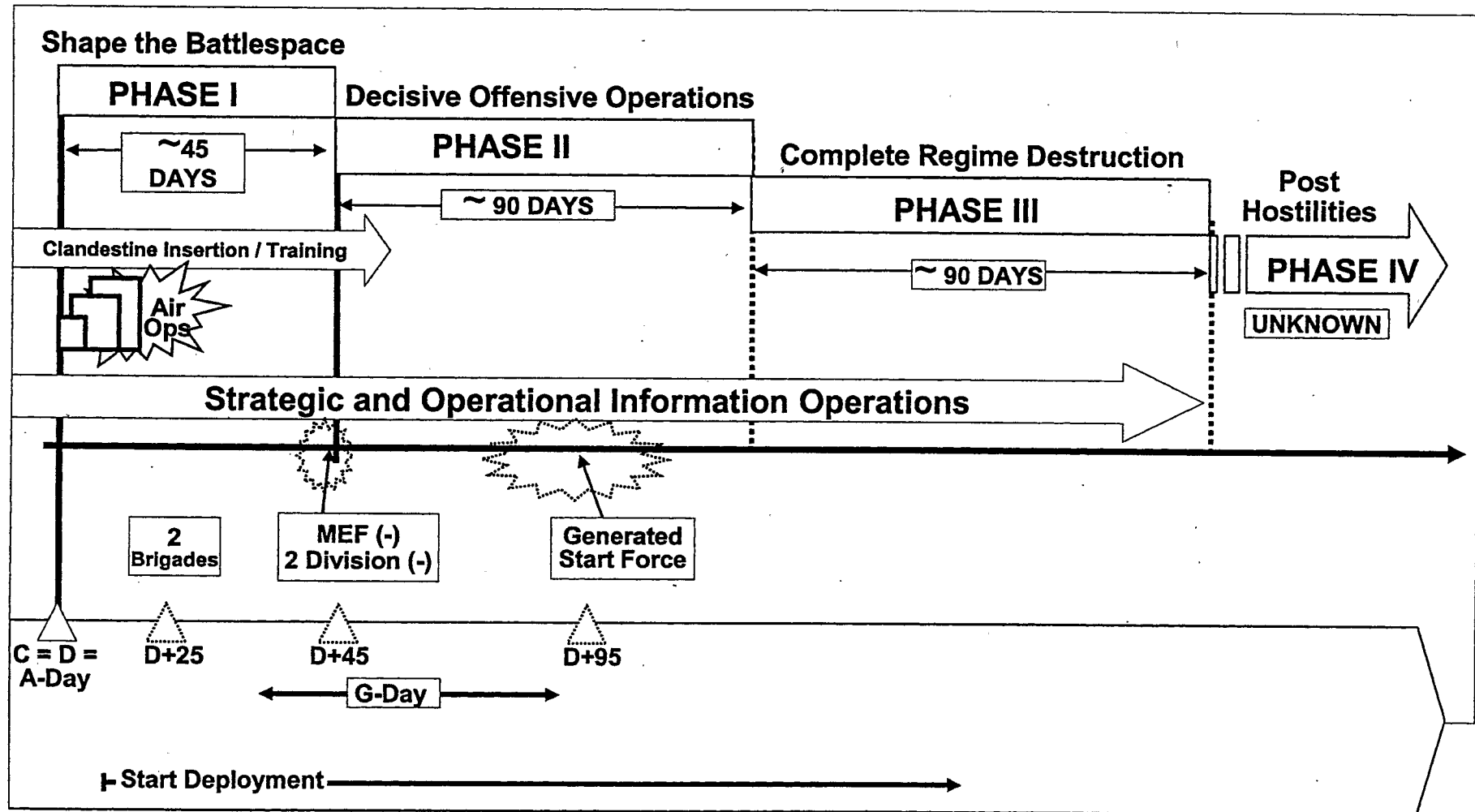

~~TOP SECRET / POLO STEP~~

A = Air Operations Begin G = Ground Operations Begin



"Modified" Plan Operational Timeline

~~TOP SECRET / POLO STEP~~

DECLASSIFIED BY: RADM R.T. Moeller
DECLASSIFY ON: 16 June 2005
ACTION OFFICER: Mr. M.D. Fitzgerald, Civ

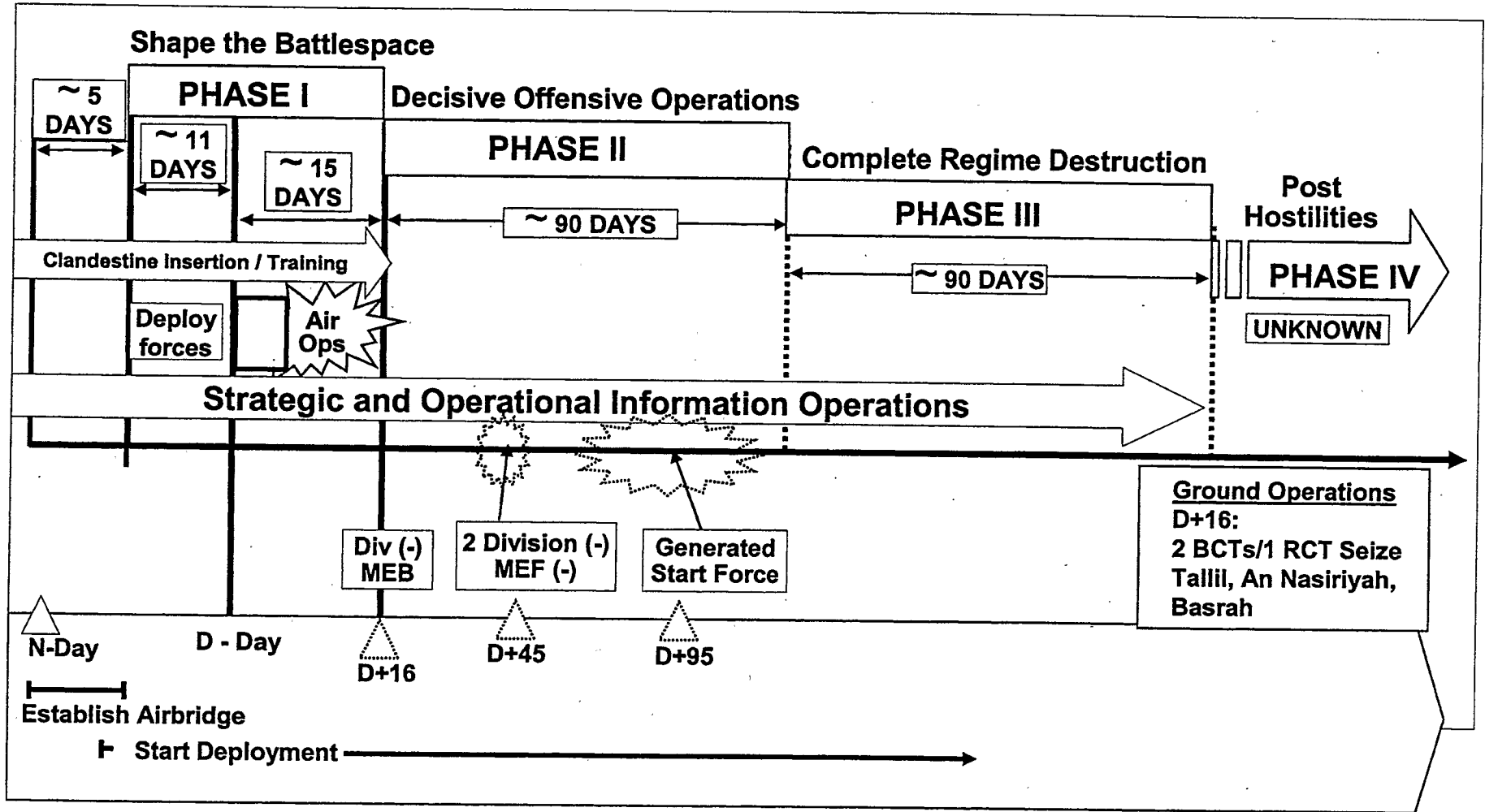

~~TOP SECRET / POLO STEP~~

A = Air Operations Begin G = Ground Operations Begin



Phase IV Actions

~~TOP SECRET / POLO STEP~~

DECLASSIFIED BY: RADM R.T. Moeller
DECLASSIFY ON: 16 June 2005
ACTION OFFICER: Mr. M.D. Fitzgerald, Civ

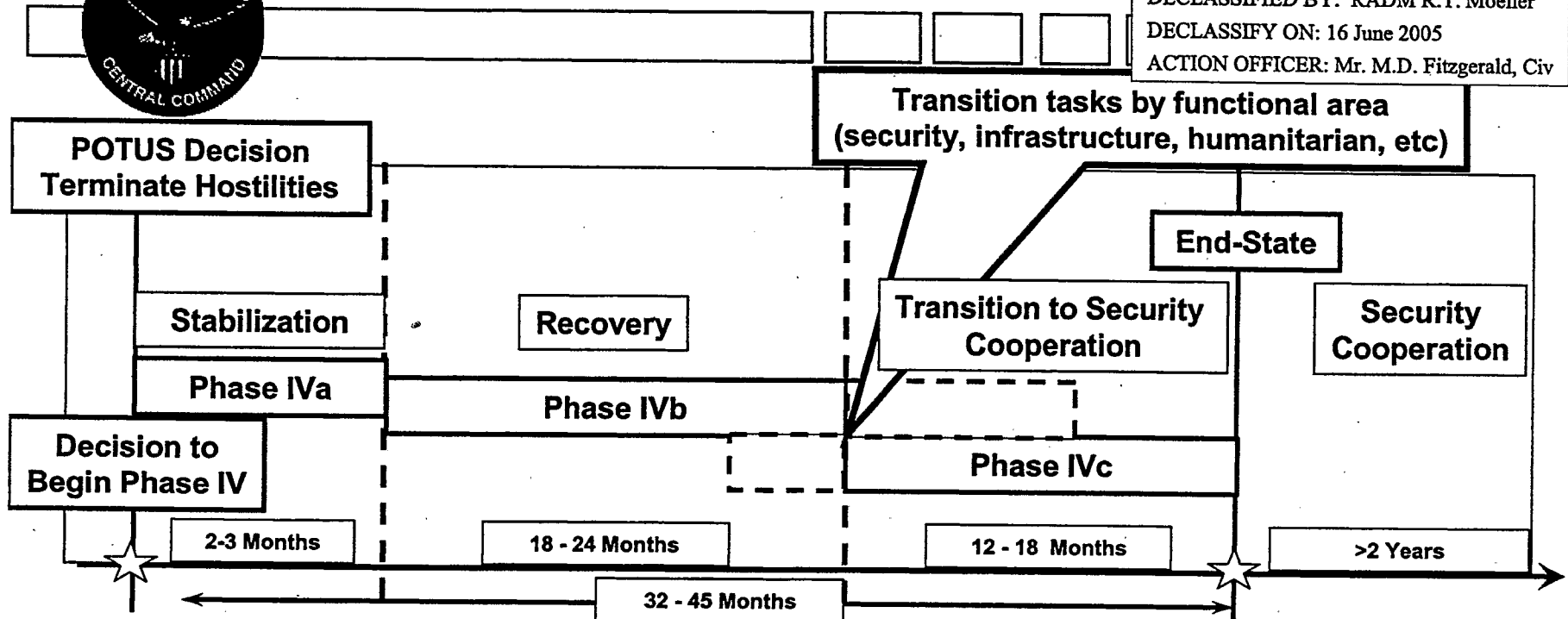

- Support the establishment of a stable Iraqi government
 - Establish a secure environment and assist in recovery and reconstruction
 - Support the establishment of Iraqi Self-Defense forces
 - Ensure the territorial integrity of Iraq
 - Transition civil-military activities to international organizations / non-governmental organizations / Iraqi Government
- Ensure WMD capability destroyed
- Gather intelligence, detain terrorists and war criminals, free individuals unjustly detained
- Re-deploy forces

~~TOP SECRET / POLO STEP~~



Generated Start Initial Force Deployment Overview

~~TOP SECRET / POLO STEP~~

DECLASSIFIED BY: RADM R.T. Moeller
DECLASSIFY ON: 16 June 2005
ACTION OFFICER: Mr. M.D. Fitzgerald, Civ

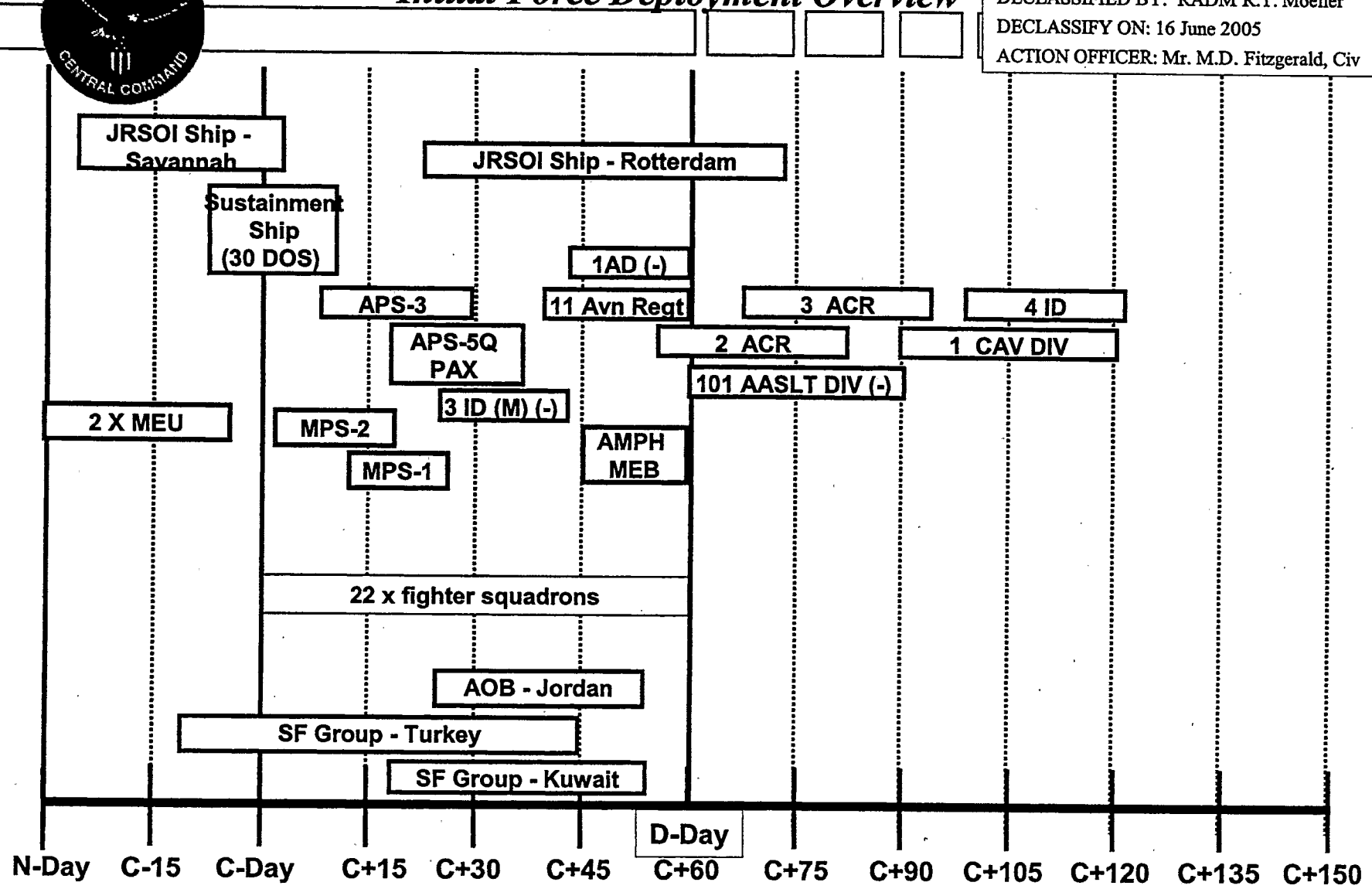

~~TOP SECRET / POLO STEP~~



Running Start Initial Force Deployment Overview

~~TOP SECRET / POLO STEP~~

DECLASSIFIED BY: RADM R.T. Moeller
DECLASSIFY ON: 16 June 2005
ACTION OFFICER: Mr. M.D. Fitzgerald, Civ

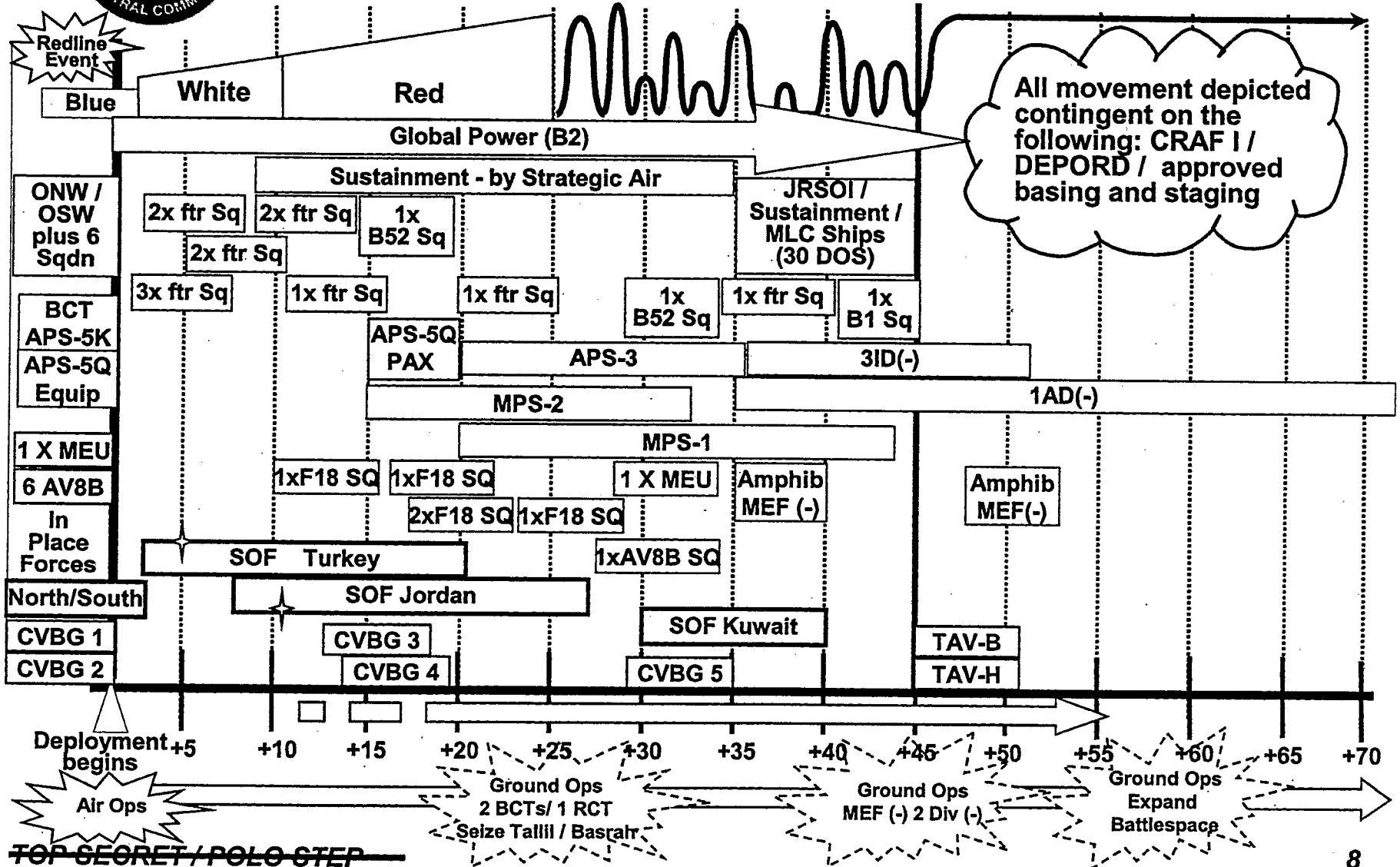

~~TOP SECRET / POLO STEP~~



Running Start Initial Force Deployment Overview

~~TOP SECRET / POLO STEP~~

DECLASSIFIED BY: RADM R.T. Moeller
DECLASSIFY ON: 16 June 2005
ACTION OFFICER: Mr. M.D. Fitzgerald, Civ

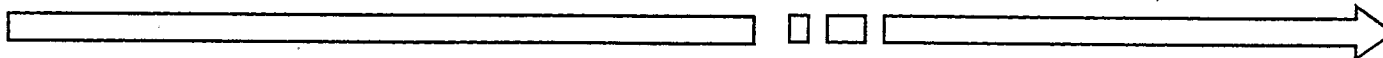
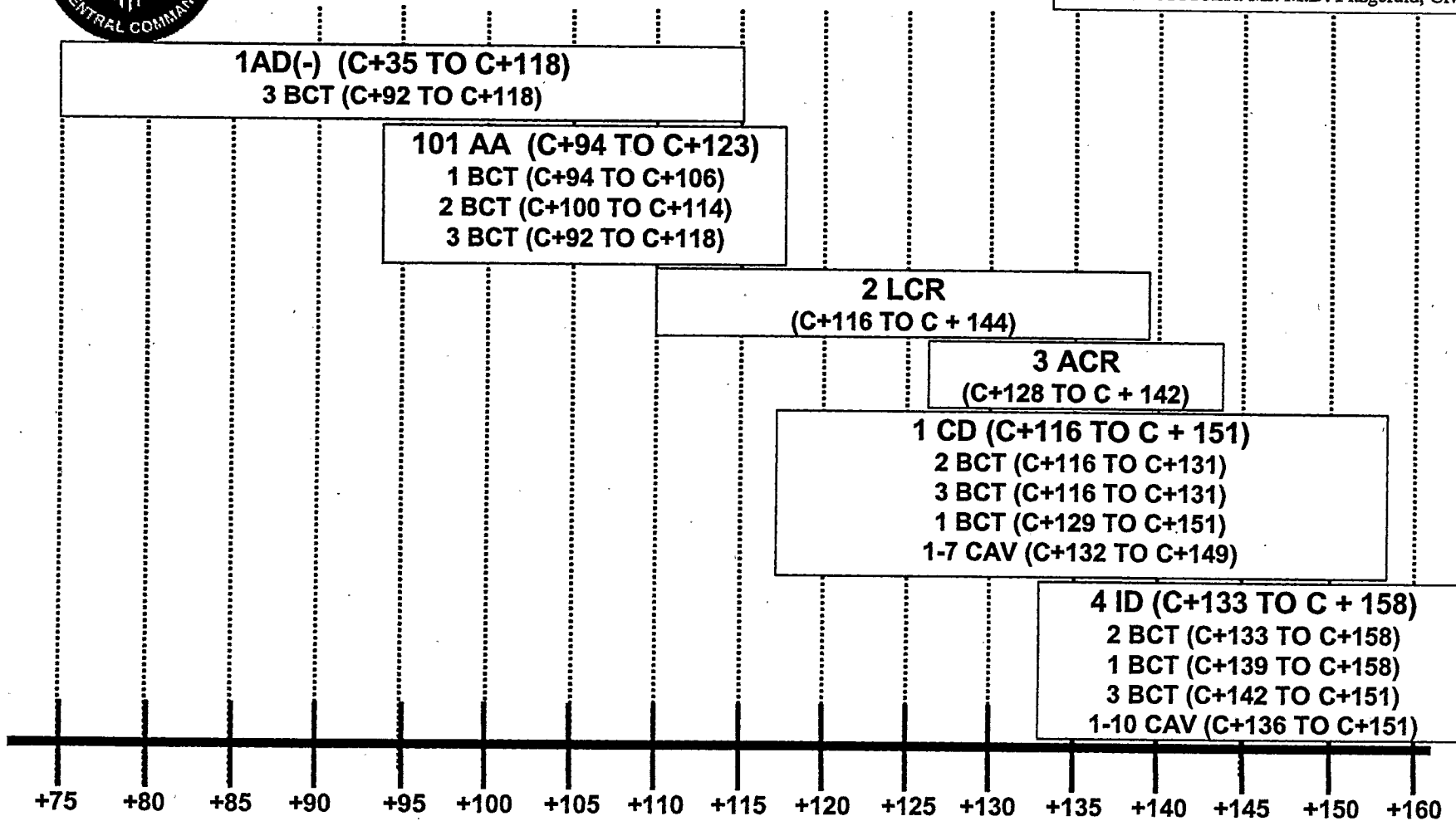

~~TOP SECRET / POLO STEP~~



Modified Start Initial Force Deployment Overview

~~TOP SECRET / POLO STEP~~

DECLASSIFIED BY: RADM R.T. Moeller
DECLASSIFY ON: 16 June 2005
ACTION OFFICER: Mr. M.D. Fitzgerald, Civ

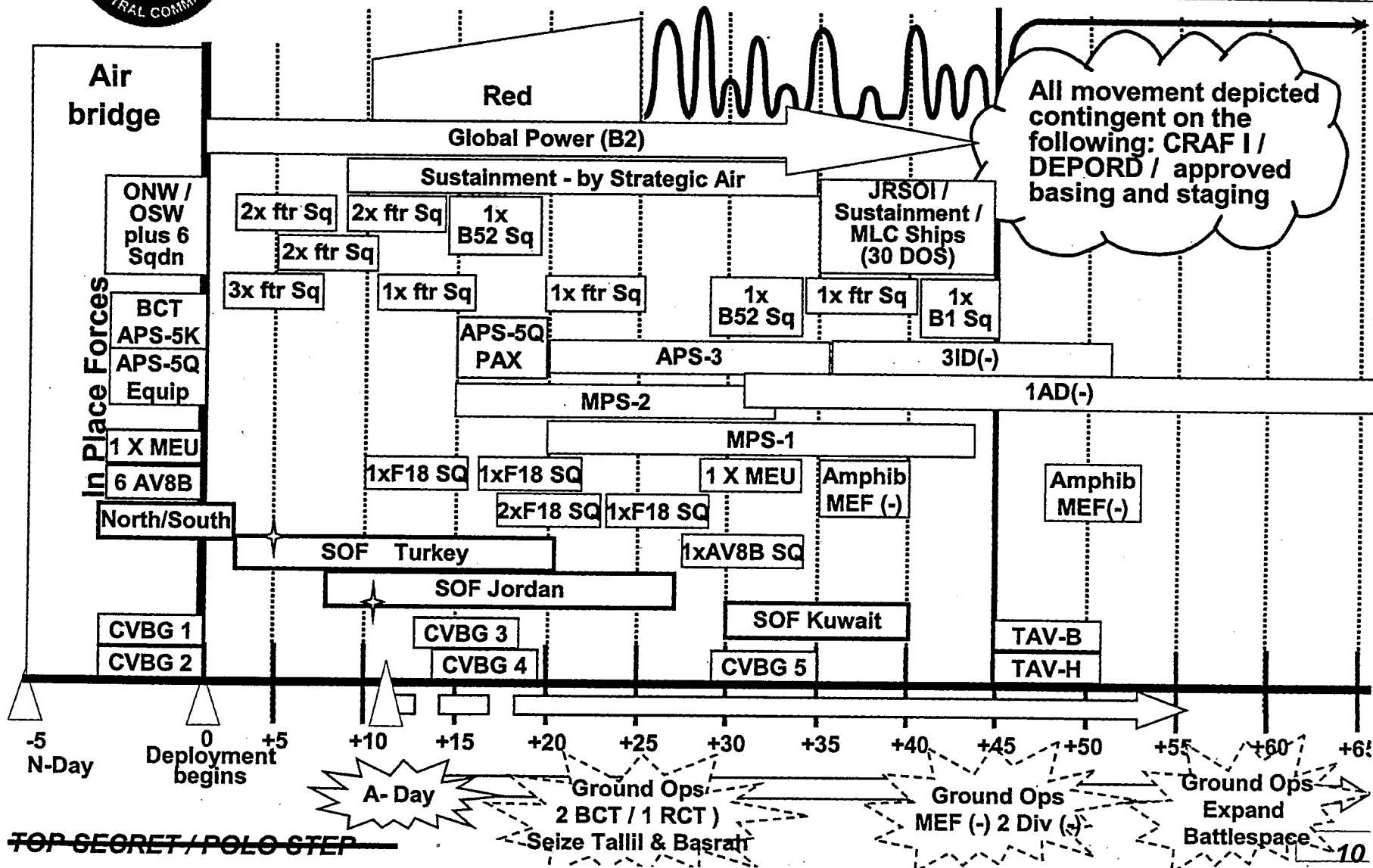

~~TOP SECRET / POLO STEP~~

Whiteman AFB, US
16 B2 (USAF)

Mediterranean

72 F18 (USN)
20 F14 (USN)
8 EA6B (USN)
8 E2 (USN)

48 GRL (USAF)

Souda Bay, CR (LBBG)

6 KC135E (USAF)
2 CH53 (USN)
2 C-130 (USN)

H5 (Prince Hasan), JO

2 MC130H (SOF)
4 MC130P (SOF)
6 MH47D (SOF)
3 MH60L (SOF)
4 HC130 (USAF)
6 HH60 (USAF)
4 RQ-1(1 MQ-1)(USAF)

Fairford AB, UK
12 B-52 (USAF)

Akrotiri, CY (LCRA)

4 U2 (USAF)
6 KC135E (USAF)

Antayia, TU (LTBF)

36 KC135 (USAF)

All Al Salem, KU (OKAS)

18 AH1 (USMC)
24 CH46 (USMC)
16 CH53 (USMC)
9 UH1 (USMC)
6 PIONEER (USMC)
6 MC130E (SOF)
6 MH47 (SOF)
7 RQ-1 (USAF)
4 MH53M (SOF)
12 UAV (USA)
2 EC-130E (SOF)

Prince Sultan (PSAB)

8 KC135R (USAF)
3 E3 (USAF)
2 RC135WV (USAF)
5 EA6B (USN)
14 F16CJ (USAF)
12 F15C/D (USAF)
2 U2 (USAF)

VIC Camp Doha (OKAD)

775 HELOs (USA)

Al Jaber, KU (OKAJ)

60 F18C/D (USMC)
30 F16C+ (USAF)
30 A/OA-10 (USAF)
16 AV8B (USMC)
4 HC130 (USAF)
6 HH60G (USAF)

Camp Snoopy, QA (OTBD)

5 C-17 (USAF)
5 EC-130H (USAF)
24 C-130 (USAF)

Al Udeld, QA (OTBH)

12 F15C (USAF)
16 F16CJ (USAF)
18 F16CG (USAF)
36 F15E (USAF)

Thumrait, OM (OOTH)

12 B1 (USAF)
7 E3 (USAF)
4 RC135WV (USAF)
11 KC135R (USAF)
2 Cobra Ball (USAF)
5 E8C (USAF)

Al Dhafra, AE (OMAM)

6 U2 (USAF)
4 RQ4 (USAF)
5 KC10A (USAF)

Burgas, BU (LBBG)

6 KC10A (USAF)

Afyon, TU (LTAH)

18 KC135E (USAF)

Incirlik, TU (LTAG)

21 A/OA10 (USAF)
24 F15C (USAF)
24 F16CJ (USAF)
24 F15E (USAF)
5 EC-130H(CC) (USAF)
5 E8C (USAF)
6 KC135 (SOF)
4 RC135WV (USAF)
10 EA6B (USN/USMC)
5 E3 (USAF)

Bahrain Int'l BA (OBBI)

6 C2COD (USN)
1 C20 (USN)
3 EP3 (USN)
2 UC12 (USN)
6 MH53 (USN)
4 PH53E (USN)
2 C130 (USN)
2 C9 (USN)
3 P3C (USN)

Abu Dhabi AE (OMAA)

24 KC135R (USAF)
9 KC10A (USAF)
28 C130 (USAF)

Masirah, OM (OOMA)

4 AC130U (USAF)
2 MC130P (USAF)
4 MH53M (SOF)
1 APEX GOLD (SOF)
4 P3C (USN)

Seeb, OM (OOMS)

3 C21 (USAF)
48 C130 (USAF)
24 KC135R (USAF)

"Running Start" C+45

DECLASSIFIED BY: RADM R.T. Moeller

DECLASSIFY ON: 16 June 2005

ACTION OFFICER: Mr. M.D. Fitzgerald, Civ

Diyabikr, TU (LTCC)

8 A/OA10 (USAF)
4 AC130H (SOF)
4 RQ-1 (USAF)
4 MC130H (SOF)
4 MC130P (SOF)
7 MH53 (SOF)
4 HC130 (USAF)
6 HH60 (USAF)

Shaikh Isa, BA (OBBS)

5 EA6B (USMC)
10 KC135R (USAF)
4 KC135 (SOF)
18 KC130 (USMC)

Arabian Gulf

96 F18 (USN)
42 F14 (USN)
12 EA6B (USN)
12 E2 (USN)

Diego Garcia (FJDG)

16 B-52 (USAF)
12 KC-10 (USAF)
3 P-3C (USN)