

~~SECRET~~

NATIONAL SECURITY AGENCY
FORT GEORGE G. MEADE, MARYLAND

CRYPTOLOG

2nd Issue 1990

P.L. 86-36

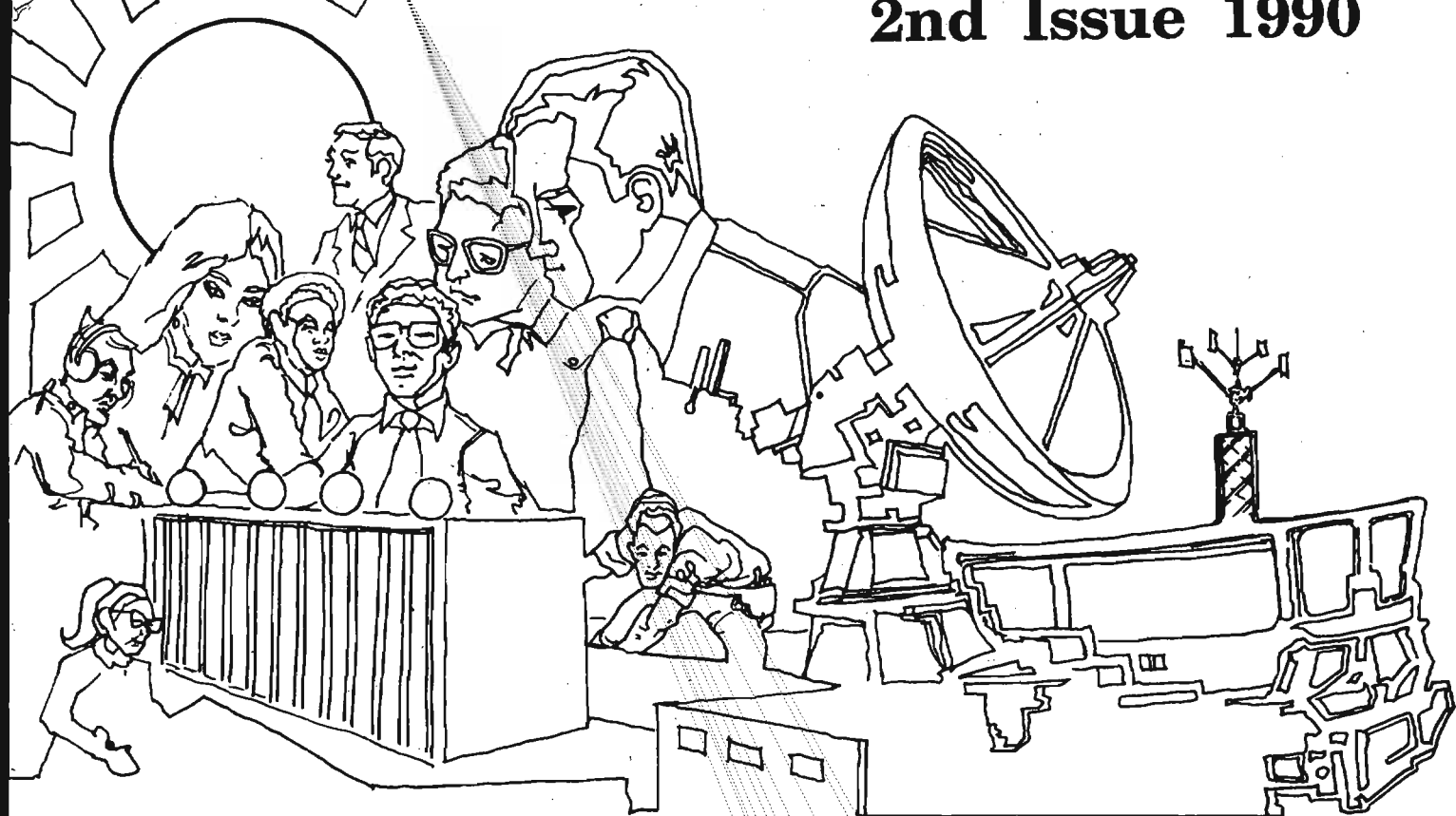

A PERCEPTION OF THE TECH TRACK NSA/CSS AND COUNTERNARCOTICS . . .	[REDACTED] . . .	1
THE NEED FOR INTELLIGENCE . . .	N. C. Gerson . . .	8
HELP WANTED . . .	David Hatch . . .	9
PLANNING FOR THE MILLENIUM . . .	[REDACTED] . . .	10
REASSIMILATION . . .	David L. Beckner . . .	13
EXCELLENCE THROUGH EVALUATION . . .	[REDACTED] . . .	16
BULLETIN BOARD . . .	[REDACTED] . . .	18
CRUCIBLE/MOSTAR . . .	[REDACTED] . . .	20
RAW TRAFFIC AND REMOTE COLLECTION . . .	[REDACTED] . . .	21
EXPERT VLSI DESIGNER HIRED FOR THREE DAYS . . .	[REDACTED] . . .	27
REBUTTAL TO 'A NOTE ON THE LINGUIST PROBLEM' . . .	[REDACTED] . . .	28
SHORT-ORDER TRANSLATION . . .	[REDACTED] . . .	29
BALLOON-INT, CIVIL WAR STYLE . . .	[REDACTED] . . .	31
LETTERS . . .	[REDACTED] . . .	33
	[REDACTED] . . .	36

~~THIS DOCUMENT CONTAINS CODEWORD MATERIAL~~

~~SECRET~~

~~CLASSIFIED BY NSA/CSSM 123-2~~

~~DECLASSIFY ON: Originating~~

~~Agency's Determination Required~~

~~NOT RELEASABLE TO CONTRACTORS~~

CRYPTOLOG

Published by P1, Techniques and Standards

VOL. XVII, No. 2 2nd Issue 1990

WHILE-U-WAIT

PUBLISHER..... [redacted]

BOARD OF EDITORS

- Editor [redacted] (963-1103)
- Computer Systems [redacted] (963-1103)
- Cryptanalysis [redacted] (963-5238)
- Cryptolinguistics [redacted] (963-4382)
- Information Resources [redacted] (963-3258)
- Information Science [redacted] (963-3456)
- Information Security [redacted] (972-2491)
- Intelligence Reporting [redacted] (963-5068)
- Language [redacted] (963-3057)
- Linguistics [redacted] (963-4814)
- Mathematics [redacted] (963-5566)
- Puzzles [redacted] (963-6430)
- Science and Technology [redacted] (963-4958)
- Special Research Vera R. Filby (968-5043)
- Traffic Analysis [redacted] (963-4351)
- Classification Officer..... [redacted] (963-5463)
- Bardolph Support [redacted] (963-3369)
- Macintosh Support [redacted] (968-7315)
- Illustrator [redacted] (963-3360)

(U) In this period of budget cuts management will be happy to learn that throughout the Agency, many analysts have devised clever ways to make every minute count. Take CRYPTOLOG's parent organization, for example, that puts out working aids of blockbuster proportions. Printing them is a chore because you have to be there to monitor the disaster-prone process in case the computer freezes up or the printer jams. What to do while-u-wait? The tradition here is to plan ahead to proofread, or scan the Read Folder, or eat lunch.

(U) This is but one modest example of many. Pride of place for productivity while-u-wait surely goes to a linguist of our acquaintance, who, a couple of crises ago, was wont to wait for his wife when her outfit was jumping and his was not. Idly he picked up a grammar book on an offbeat language that piqued his curiosity. Yes, you got it! While-he-waited the many months of that crisis he gained sufficient proficiency to become certified!

To submit articles or letters by mail, send to:
 Editor, CRYPTOLOG, P1, NORTH 2N018

If you used a word processor, please include the floppy or cartridge with your hard copy, with a note as to what computer, operating system, and software you used.

via PLATFORM mail, send to:
cryptlg@bar1c05
 (bar-one-c-zero-five)
 (note: no 'o')

via ALLIANCE, send to:
 PLBROWN [note: all caps]
 attn: CRYPTOLOG

Always include your full name, organization, and secure phone; also building and room numbers.

~~(C-CCO)~~ A more exotic while-u-wait chore was undertaken by a voice linguist listening to search. As some of you well know, it requires intense concentration to listen through the static for tiny segments of intelligence that crop up at long intervals between the "music of the spheres." There's not much you can do but sit there and listen, hands idle. But this analyst found that you can do needlepoint. Keeping hands busy in a way that does not occupy the mind serves to lessen the tension of intense concentration, and so permits longer stints without a break.

For Change of Address
 mail name and old and new organizations to:
 Editor, CRYPTOLOG, P1, NORTH 2N018
 Please do not phone.

Contents of CRYPTOLOG may not be reproduced or disseminated outside the National Security Agency without the permission of the Publisher. Inquiries regarding reproduction and dissemination should be directed to the Editor.

(U) And there's no doubt that readers can contribute stories that top these!

All opinions expressed in CRYPTOLOG are those of the authors. They do not represent the official views of the National Security Agency/Central Security Service.

A PERCEPTION OF THE TECH TRACK

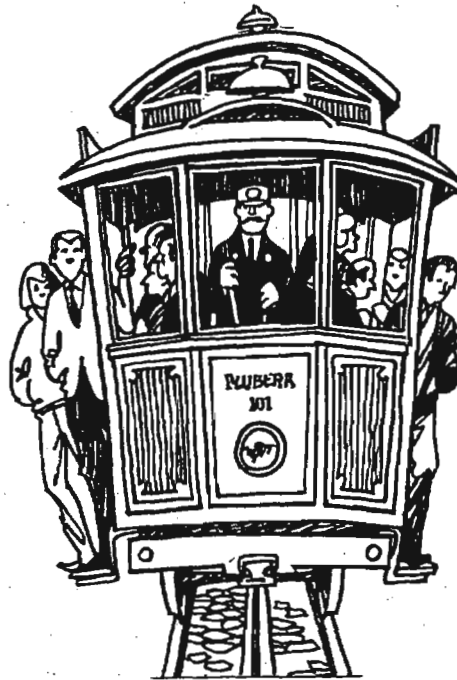

~~(FOUO)~~ The technical track program is an issue of considerable concern to career Agency analysts. Despite all the recent activity, there is skepticism about the viability of the program. For that reason, P16 and the DDO Language Advisory Committee have been looking at various aspects of the issue. They have conducted several rap sessions with senior linguists in grades 14 and 15 to gain their point of view about the technical track and technical language careers. The following remarks focus on linguists but apply equally to the other DDO cryptologic and analytical disciplines.

~~(S-CCO)~~ The sessions revealed a widespread cynicism about the existence and future of a technical track. Most analysts see no real progress in the development of the track or appealing advancement opportunities.

P.L. 86-36

P16

~~SECRET~~

(U) Individuals opt to remain in their technical specialties because of their technical professionalism, their devotion to duty, and their sense of mission, rather than as a result of the Agency's efforts to promote a technical career system.

(U) The linguists with whom I met agreed that the technical career situation, specifically promotions to GG-14/15, has considerably improved over the past several years, and they are encouraged by that. But a closer look at the current crop of senior linguists reveals that many achieved success only through a "detour" into management. It is true that the technical health of the organization benefits if people opt to return to the technical track after reaching grade 14 or 15. But the message is not ignored by junior technical employees looking toward advancement.

(U) Also, while one is "detouring", technical expertise is temporarily, perhaps permanently, lost so that others must be recruited and trained to fill the void.

(U) Pessimism is heightened by the fact that there will be very few open STE billets over the next several years. We need a healthy technical track program to ensure that we make the best use of those that become available.

THE PROSPECTS FOR LINGUISTS

~~(FOUO)~~ When we look at the present distribution of Senior Technical Experts in the Agency, we find that a disproportionate number are in mathematics, engineering, physical sciences, and data systems. Our first reaction is concern that the analytic specialties are not sufficiently represented in the STE ranks. I propose that the problem, for linguists at least, actually begins at grade 15.

There-

fore, the pool from which language STEs may be drawn is very small, a fact that adds to the frustration, skepticism and cynicism felt by the more junior linguists who would aspire to technical careers.

~~(FOUO)~~ One might ask why linguists are not being promoted in greater numbers since language has been classified as a critical skill by NSA for years. Do promotion boards not think linguists deserve to be elevated to the senior grades? Do they fully understand the role of linguists and the skills required?

~~(FOUO)~~ The present dearth of GG-15 linguists is in part the inevitable consequence of a situation that prevailed two decades ago when it was not possible to go beyond a 12 as a "pure" linguist. That grade ceiling has been attributed to the misperception of a few senior managers that "anyone can translate given a dictionary." In fact, one senior manager considered language work to be of a clerical nature. So linguists left the field to seek advancement.

WHAT LINGUISTS DO

(U) Though the managers mentioned above are long gone, and, let us hope, their perceptions with them, it might be well to pause here to consider just what it is that linguists do.

EO 1.4.(c)
P.L. 86-36

~~SECRET~~~~HANDLE VIA COMINT CHANNELS ONLY~~

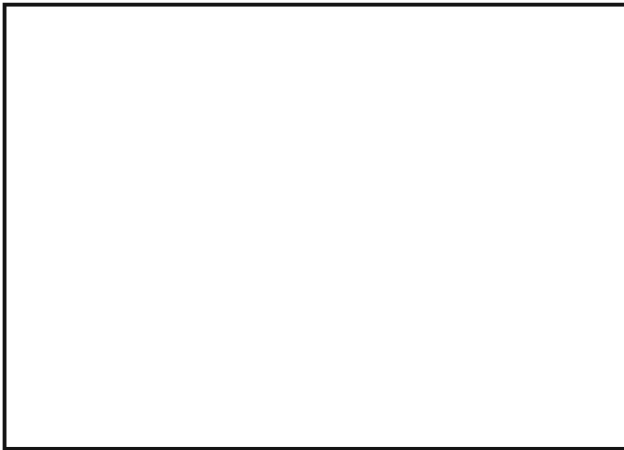

DESIGN FOR A TECHNICAL TRACK

~~(FOUO)~~ An effective technical track must provide a clear and objective set of qualification standards that will permit technical careerists to know what is expected of them in order to qualify for advancement to the senior ranks, including STE. It will have to produce a record that demonstrates unequivocally that sufficient numbers of people can reach the senior grades without substantially departing from a technical career path. Moreover, the advancement for qualified technical experts must be as rapid as it is for those who choose other career paths, such as management-staff. That is to say, a technical track program cannot be viewed as truly successful when people are not being promoted to the senior grades, including Senior Technical Expert, until they are in the final years of their 30-plus-year career.



It requires years of dedicated study (much of it self-study) and experience to master a rare language. Aside from language skill per se, the linguist must also become fully knowledgeable of the target, its organizations, personalities, history, customs, lexicon, communications, and so on, in order to be a truly effective SIGINT linguist.

~~(FOUO)~~ At present the numbers do not add up to convince smart young people to choose a technical career over one in management.

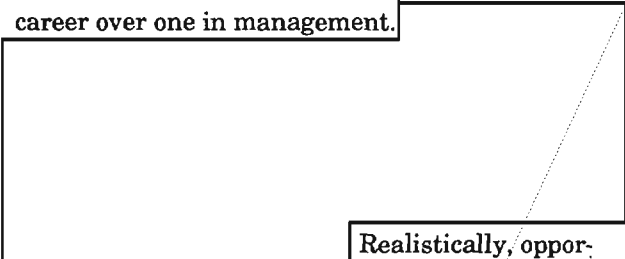

~~(FOUO)~~ These skills do not come easily or quickly. To become a true professional, a linguist requires considerably more dedication and effort than is generally assumed. The effort is so great in some instances that other less challenging and more rewarding avenues appear to offer more appealing opportunities. That is why it is so necessary to establish a viable technical track program in DDO.

Realistically, opportunities to become grade 15 are more severely limited than is obvious because each discipline has its own technical track.

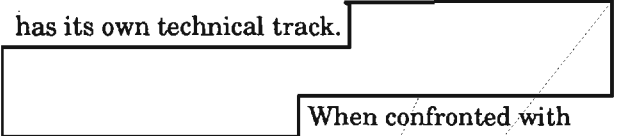

When confronted with these numbers, it is little wonder that many technicians opt for management. The fact that some of them eventually will "opt", for various reasons, to return to the technical track after a number of years, should not comfort us a great deal.

(U) While I would not suggest total parity or a quota system among occupational specialties or between the technical and managerial/staff tracks, I do believe the Agency, and especially DDO, must give greater attention to senior level promotions to technical careerists. We want to encourage analysts to devote as much of their careers as practicable to their specialty. If but half of all past technicians had remained in their specialty, this Agency would be in a remarkable state of technical health!

(U) Though the Agency points with justified pride to a low attrition rate vis-a-vis other government agencies, the figures reflect attrition from the Agency, not the internal attrition from the analytic specialties into staff and management positions. While this is not counted officially as attrition, the effect is about the same, that is, loss of highly trained resources for which the Agency spent substantial sums to recruit, hire, and train, and for which additional sums must be spent to obtain replacements.

A PROPOSED SOLUTION

(U) The time has come for the Agency to give serious consideration to a new way of thinking about the grade structure of a technical track. The traditional pyramid, bottom-heavy with fewer and fewer people as one ascends in grade must give way, if not to an inverted pyramid, then certainly to a structure in which the ranks of the upper grade levels are somewhat larger than the lower ones. If our efforts to establish a technical track be truly successful, we should expect to have most people remain in their technical speciality for their entire careers of 30-plus years. We must hold out a reasonable promise of promotion to the senior ranks for the most deserving. And if the programs succeed, the numbers of deserving should similarly increase.

PROMOTION TO STE

(U) The manner of determining who should be selected (or promoted) to the senior technical expert ranks needs to be critically reviewed. We generally agree that fellow technicians recognize fairly accurately who among their ranks stand out from the crowd and who deserve to be senior technical experts. Currently, the Senior Technical Review Board does not act autonomously, nor does it conduct a true zero-based review of all eligible GG15's. To a very large degree, consideration of individuals proceeds as for all other Agency promotions, i. e., they are organizationally initiated and are processed in a linear fashion.

(U) But the selection process should reflect the notion that senior technical experts are, in the truest sense, all-Agency assets. At present, organizational constraint causes candidates to be placed in priority order, regardless of the areas of technical expertise they represent. Promotion review boards are, in their turn, constrained to review the candidates in a similar priority order. At no time is consideration given that this or that technical area needs to be represented by an appropriate array of experts. Nor do managers necessarily know how their respective technical peers view these candidates.

(U) Candidates for the STE ranks should not be processed linearly but rather in parallel, especially when they represent different areas of technical specialization. And since senior technical experts are technical resources available not just to the immediate manager who nominates them, there should be no concern as to the experts' grade vis-a-vis that of their administrative managers.

(U) To overcome some of these problems with recommending and promoting people for Senior Technical Expert, I strongly recommend that potential candidates for Senior Technical Expert be identified, and ultimately recommended for promotion, by their peers, with management playing, if it must play at all, a minor role in the process. High-level promotion boards should be composed of a fair representation of the organization's technical specialties, and where possible, members should be drawn from the STE ranks. Each board should be empowered to conduct zero-based reviews and should not be constrained by organizational recommendations. The chairpersons of the career panels might play an active role in the peer review process for Senior Technical Experts.

TECH TRACK POSITIONS

~~(FOUO)~~ Designating positions in a technical track program seems to be a very sensitive issue. There is a desire not to lock ourselves into the constraints of graded positions, as is the case for the management track. I support this notion generally. Although we do not view them as such, in reality most staff positions, especially in the operations elements, are technical positions. We have reporters, collectors, data systems analysts, cryptanalysts, traffic analysts all who provide technical support and advisory services at office and group levels throughout DDO. And there are also a few staff positions in any organization, especially at the group level, that warrant being established at the rank of STE. In the language career specialty, for example, each group has "established" a senior language advisor. Regardless of where these individuals sit organizationally, the scope of their responsibilities and the impact of their activities on the organization could well warrant the rank of STE.

~~(FOUO)~~ Besides the thorny issue of technical track positions, there are several other problems which those who are designing technical track programs must address. One of these has to do with transportability. Development of technical track programs in DDO is proceeding along group, and in some cases office, lines. For most linguists, a group-level program does not pose severe barriers to their mobility. The problem arises when linguists who have attained a given status in one organization then choose, for career diversification and enhancement, to seek an assignment in a different organization.

(U) With the exception of the recently published G Group Technical Track Program, none of the extant program documents deal explicitly with the question of transportability of qualifications and technical status, although there seems to exist a tacit understanding that would grant the transferee some credit towards meeting technical track criteria in a new organization.

~~(C-CCO)~~ In many SIGINT language environments, multilingualism is an important factor in operational success. Therefore, a viable technical track program must accommodate multilinguists and provide the necessary transportability of status to encourage them to stay in the technical track.

DIVERSITY FOR TECHNICAL TRACK LINGUISTS

(U) Another concern for the designers of technical track programs, as well the tech trackers themselves, is how much diversity in career is acceptable and desirable. It is unreasonable to expect that all individuals will be content to remain in the same job for an entire career. The problem is identifying appropriate diversifying experiences

for each technical career. Both individuals and organizations benefit from a certain amount of interdisciplinary experience.

~~(C-CCO)~~ Diversity comes in several forms:

diversity of application within the specialty.
In the case of language, there are options such as voice vs non-voice, language teaching, staff assignments performing language research, career panel tasks, and so on.

assignments that emphasize associated cryptologic disciplines, such as intelligence reporting, traffic analysis, cryptanalysis, collection.

acquisition and application of different languages.

supervision of other linguists, especially in language-related SIGINT activities.

(U) But these experiences must not so diffuse technical expertise in the language so as to render that proficiency inadequate to perform highly skilled technical language tasks.

(U) The individual is usually the best judge of when a career change is needed: when burnout occurs, when boredom begins to set in, when enthusiasm wanes, when creativity falters, when productivity drops. Even when an individual knows what the change ought to be, doing something about it is another matter.

THE ROLE OF MANAGEMENT

(U) This is where management plays a crucial role in the success of the technical track program. By being sensitive to the needs of the individuals as well as of the organization, managers can steer careers in directions that will optimize the individuals' potential and improve the chances that they will pursue a rewarding technical career. This is a management responsibility that cannot

be taken lightly. American business has been faulted for its short-sighted views on long-term investments and profits. I fear that Agency management often takes the same view when it comes to managing human resources.

(U) It is difficult, maybe impossible at times, to look at particular individuals in terms of their future potential and development when the press of international events demand all of our attention today. Being able to do it, however, is a trait that differentiates a good manager from a manager in name only. Planning for the future is not just a corporate responsibility, it is the personal one of every manager.

~~(FOUO)~~ Management must afford technical trackers additional opportunities and challenges for growth. With experience and training, technical trackers become technical leaders. This means involvement in the technical management of targets, participation in advanced and specialized language study wherever offered, active participation in professional associations, both inside and outside the Agency, and interagency activities associated with the target or language, and opportunities for travel. These are but a few incentives that could be offered to technical trackers. They must be valued and used for the technical knowledge and experience they possess and can bring to bear on the accomplishment of the organization's mission.

TECHNICAL LEADERS IN LANGUAGE

~~(FOUO)~~ Besides knowing their language in depth and breadth, technical leaders possess a critical knowledge of the targets associated with the language or languages. The most valuable asset of long-term technical track analysts is target continuity. With it, discrete and seemingly unre-

~~SECRET~~

lated and unimportant facts, often separated in time, become intelligence nuggets. This is a subtle and intangible benefit that comes when people remain productively associated with targets over long periods of time.

~~(FOUO)~~ Technical leaders have the ability to perform professional quality research and to produce working aids that advance the technical health of their specialties. They must also be able to impart to junior analysts the knowledge and experience they have gained. Above all, senior technical language experts are superior analysts and reporters in their own right. They can analyze incomplete material and derive meaningful information from it, and then convey it with facility precisely in correct English.

~~(FOUO)~~ The Agency now possesses a fair number of linguists in the senior grades who are well on their way to meeting the standards of senior technical expert. It remains to the DDO and its managers and the Agency senior promotion boards to ensure that these talents are properly recognized and used. While not the only solution to encouraging technical careers, an effective DDO technical track program should go a long way in stemming the hemorrhaging of technical talent in DDO.

PATH vs TRACK

(U) When discussing technical track careers, we generally refer to a technical track program as the administrative infrastructure under which such careers are to be "managed." The notion of a program suggests a certain structural rigidity with terms and conditions that an individual must satisfy in order to progress to the next level. Track suggests a unidirectional movement with little or no opportunity for the diversity discussed earlier. Flexibility is not generally viewed as a

feature of "program." Therefore, in the context of technical careers at NSA, we should more properly refer to technical career development or pathing system, for no two career paths will likely be the same, yet the end results may be quite similar.

(U) Career pathing takes into consideration the strengths and weaknesses of both the technicians and the organization. Technicians are presented with career options that most effectively will lead to their career objective. These options and the actions to effect them are discussed and acted on in consultation with concerned managers who, in turn, have the authority to carry out the career pathing plan.

REPRISE

(U) The Agency will have to do some belt-tightening; that is a fact of life being discussed in every corner of the buildings. Protecting our investment in technical talent is essential. Simply put, we need effective, flexible programs to retain the skills we need to support our unique mission.

Notice to Subscribers

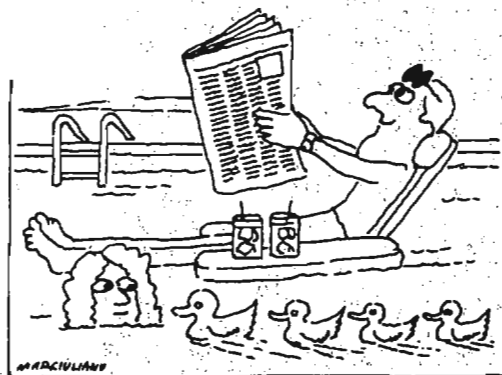

The distribution for this issue reflects changes received by COB 5 July 1990

~~SECRET~~~~HANDLE VIA COMINT CHANNELS ONLY~~

NSA/CSS and COUNTERNARCOTICS

P.L. 86-36

P05/SAO

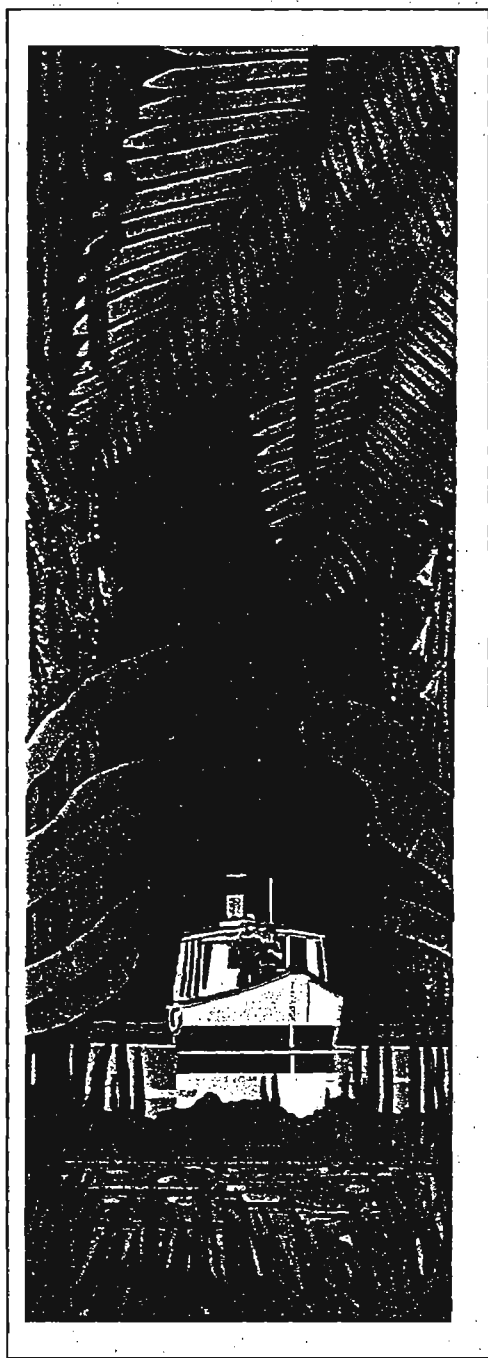

(U) As most of you know, NSA has recently become heavily involved in the US Government counternarcotics effort. We have established the following guidelines for the classification of counternarcotics-related information:

- (U) The fact of NSA/CSS association with the US Government counternarcotics efforts is UNCLASSIFIED.
- (U) The fact of an association between DEA, Customs, US Coast Guard, FBI and NSA with counternarcotics is UNCLASSIFIED.
- ~~(C)~~ The fact of a SIGINT effort against international narcotics traffickers is CONFIDENTIAL.



- ~~(C)~~ The association of NSA/CSS personnel by name, organization or location with a SIGINT counternarcotics mission is CONFIDENTIAL.

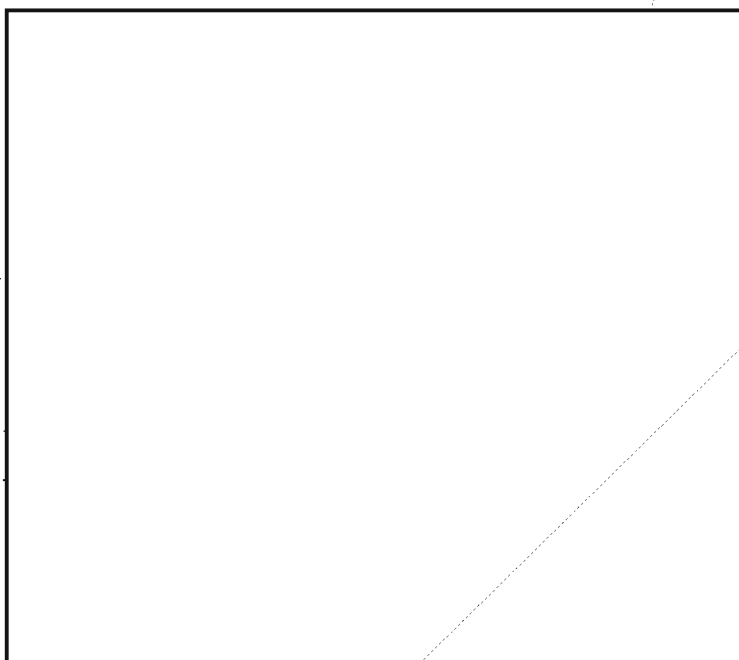

N.C. Gerson, R606



~~(S-C)~~ During the Korean War, the USAF's F-86 Sabre jets had a kill ratio of 10/1 over the North Korean MIGs. It was widely believed that this superiority indicated the better reliability and fighting capabilities of US aircraft. This belief, however, was erroneous. The superiority resulted from the knowledge provided by SIGINT. This ratio was possible only because the US intercepted and read instructions to the pilots broadcast by the North Korean control tower on High Frequency (HF). The information was sanitized and given to the pilots as "radar plots." The US pilots knew where to fly to intercept the North Korean MIGs.

~~(S-CCO)~~ But in 1952 North Korea shifted the tower broadcasts to Very High Frequency (VHF). There was no equipment in the field to intercept these frequencies. Without the intercepts, the kill ratio dropped to 2/1. The USAF found the losses unacceptable, so there were stand-downs and limited operations until we could ship the necessary receivers to the field. The official reason given for curtailing US fighter activity was "weather."

~~(S-CCO)~~ When the VHF receivers were deployed, North Korean air traffic again could be intercepted, and US Sabre jets could again be directed to the North Korean flight paths. The kill ratio

climbed back to 10/1. In short, SIGINT, not weaponry, provided the margin for victory.

(U) We also might recall that during the battle of Midway, aircraft from distant carriers sank a major portion of the Japanese fleet whose location was derived from SIGINT. These examples amply illustrate that the outcome of any battle strongly depends upon knowledge of the adversary's location, strength, and intentions. The mightiest navy in the wrong ocean, the strongest air force in the wrong region, or the best army in the wrong place cannot win a battle.

(U) Indeed battles, both military and diplomatic, can be won with lesser strength if adequate information is available. Further, intelligence is necessary to a nation's political well-being as well as to its military success. It is the function an intelligence service to ensure that its government is not surprised. It should anticipate the movements and trends of other nations to enable its government to chart its own course and to take advantage of opportunities as they arise.

(U) We must never forget the old Chinese adage: "The commander who will not give silver for information should not be a commander." Funds for weaponry can be cut drastically, but funds for intelligence can be cut only at our peril.

<p>RESTAURANT SUPERVISOR DINING ROOM SUPERVISOR, HOST/HOSTESS, WAITER/WAIT- RESS. All in person. Mon-Fri, Devon Bar & Grill, 2900 Penn. Ave. NW, 822-5400</p> <p>RESTAURANT—Expert bride ser- vice for Koder style del. M-F, 6am-3pm. Good pay. 526-1800</p> <p>RESTAURANT—F/T help needed to operate large health club restau- rant in the 5000 block. Back of front of the house exp. Daytime, even., & some wknd. hrs. Must be self-motivated, responsible & hard- working, and must have own transportation. Benefits incl. full use of facility, dental/medical, along w/ profit sharing. Call Ed at 590-5700, M-F, 11am-6pm.</p> <p>RESTAURANT FIT & F/T Saus Chef, Cooks, Dishwasher, Servers, Fine Dining exp. necessary. Apply in person. 2-5pm. Super Plate Restaurant, 9710 Meade St., Fairfax, Va.</p> <p>RESTAURANT MANAGERS Senior & trainee positions. 274-1710</p> <p>RESTAURANT MANAGEMENT Are you a resource who is being wasted. If you have food manage- ment expor. we want to talk to you. Up to 6326-684-9434</p> <p>RESTAURANT MANAGEMENT Drive Your Mgmt Experience To New Horizons Due to our aggressive expansion program in P.O. County, Howard Restaurants, Inc. has immed. open- ings for Managers, M/F. Must be 21yrs or older. Excellent starting salary, health & life insurance, paid vacation & training and pension plan. Call M-F, 6am-6pm, 923-0006 or send resume to: Howard Restau- rants, Inc. 1400 Mercantile Ln, #712, Landover, MD, 20785.</p> <p>RESTAURANT PHILLIPS FLAGSHIP On Washington's Waterfront We are currently seeking individuals for the following full & part-time positions. We offer a comprehensive training program.</p>	<p>RETAIL SALES BLACK, STARR & FROST Fine Jewelers Since 1910 We are searching for top level sales professionals with fine jewelry experience for our newly remodeled Fair Oaks Mall and Metzta Gallerie locations.</p> <p>Each individual must be highly motivated, have impeccable appearance and desire to work with the best gold, diamonds & watches. Applicants must recognize the importance of service and professionalism business. Excellent salary commission & benefits. Call Mark Gabriele-Randy Stein, 344-7000 Fair Oaks-Scott Lb Du 761-4218.</p> <p>RETAIL SALES CHESAPEAKE KNIFE & TOOL Challenging F/T positions avail with growth potential. We see motivated, responsible help at sev- eral locations. Right persons eligible to become Asst. Manager Good atmosphere, pay & bene- fits. 428-5441.</p> <p>RETAIL SALES—Exp for sm art glass retailer w/locations in Union Station & Georgetown. 525-4882</p> <p>RETAIL SALES—FABRIC Exclusive fabric shop seeks fashion conscious salesperson Sewing knowledge required. Good salary. Full Time or Part Time 871-0255</p> <p>FABRICS UNLIMITED OF ARL RETAIL SALES—Mature salesperson needed for elegant bridal boutique in Alexandria. Exp. preferred, but not necessary. EXCEL pay & bene- fits. F/T/P/T. 549-0307</p> <p>RETAIL SALES BUNNING & YENNIS SPECIALTIES STORES Looking for several serious and hardworking people. Full & part-time positions available. In- cluding management possibilities. Call: Rockville 770-9177-811 Baltimore 784-0558-Lee.</p> <p>RETAIL SALES STORE MANAGER</p>	<p>\$70,000+ (commission) San Diego-based multi firm expanding in the Wash area. Looking for highly motivated, energetic individuals to help with our expansion & growth. P/T/F/T, various positions avail. Mark Friedlander, 381-744-7401</p> <p>NEW OPPORTUNITY: RESEARCH PROFESSIONALS College education prefer, but not necessary. We offer the following to those who qualify for our train- ing program. • Realistic 1st year earning \$48K-150K+ • Comprehensive benefit package • Health insurance plan • 401K Pension Plan</p>	<p>SALES & SALES TRAINEE Does \$48,000+ interest you? Sales exp. helpful, but not necessary. Above average guaranteed weekly pay against excellent incentive pro- gram. Appointments furnished from aggressive advertising cam- paign. Full benefit package. Call Mr. Collins at 932-2714.</p>	<p>Career oriented from recv. in busy Alex. Co. Planned writing com- p. Call Dr. DeYoung</p> <p>SECURITY CRABSTAKE Opportunities in MD & Annapolis. Mon. Tues., 8005 Annapolis Rd. L.L. (Landon Shopp)</p> <p>SECURITY OF 3 Positions Of 120-DAY RET BONUS-\$25 \$1000 retention bonus year for full-time and plus Drug Store, 4 fringe. Competitive holidays, vacations, health & life insur- ance. See Insp. Good St. NE, everyday of 7am-11pm. Please br birth cert and Social S</p> <p>SECURITY Control Investigati has openings for an- nual officers for FT work officers must have own trans. Apply M-F 10A Backlicks Rd. Ann 354-7575</p> <p>SECURITY SCI needed at Nat'l. Air to start w/ write up flight benefits. Paid leave. Drug test re- 243-7272 Mon-Fri, 10a</p> <p>SECURITY GUARDS— night shift. Prev security exper. pref., skills in public relation to handle stressful sit- uations. Excellent benefit package. Previous exp not req'd. Apply in Arlington University Campus Safety, 2007 Rd., Arl., Va., 22207. E Security</p>	<p>SIGINT and INFOSEC PROFESSIONALS</p> <h1>HELP WANTED</h1> <p>The Center for Cryptologic History is soliciting your help in obtaining information about past events. The information is needed for a series of studies about events, crises, projects, and programs that have marked turning points in the development of NSA and the cryptologic community.</p> <p>Send your contribution to: David Hatch, D93</p>	<p>SALES DAWNTON Mobile Communications VA & MD LOCATIONS Quicker seeks prof. sales people to market the hottest new products on the market today - cellular car phones, fax machines, auto secu- rity systems, etc.</p> <p>position in the East Coast's fastest growing auto organization, if you are aggressive, motivated, & want to make money, apply in person to Mrs. Green at DARCARS Toyota, 12218 Cherry Hill Rd., Silver Spring, Md.</p>
---	--	---	---	---	---	--

The Center for Cryptologic History is soliciting your help in obtaining information about past events. The information is needed for a series of studies about events, crises, projects, and programs that have marked turning points in the development of NSA and the cryptologic community. Some of the studies will focus on our role in national and international affairs, others will illustrate how cryptologic information has been used in support of decision makers, and still others will be case studies designed to benefit a new generation. Especially in the development of cryptologic policy and practice we hope to offer "lessons learned," which means including particulars of problems, failures, or negative effects.

We are also very interested in documenting the often unsung but crucial support or "housekeeping" functions which enable NSA and the cryptologic community to stay in business but which often fail to get the recognition they deserve.

D9 has inherited a provisional listing from earlier compilations. But we need your input to compile a more broadly based working list of

topics and to reconsider the relative priority of the studies to be produced. We believe that each of you has had personal experiences or knows of such matters; it is very likely that every individual is in a position to contribute an obscure fact or a unique perspective.

The form and wording of the questionnaire are not meant to be delimiting factors but rather, as prompts to your memory. Do not interpret the questions broadly, and do feel free to add any information you consider worthy of our attention. (This will be read by human beings!) Our purpose at this initial stage is simply to collect as much information as possible, then collate it, put it into manageable form, and calculate relative priorities for study.

Any length will do, from *War and Peace* to a paragraph, classified appropriately.

Thank you.

Remember to classify appropriately

Name of submitter Present Position

Organization Building Secure phone

Please return your responses, classified as needed, to Dr. David Hatch, D93, SAB 2, Door 22. He can be reached on 972-2355

1. Can you recall a situation in which you wished you had a historical background study to reference or consult?

2. In your current operations, would you find a historical study of use? If so, on what subject or of what nature?

3. What other events, projects, or programs might provide beneficial case studies if documented by the CCH or what support functions should be studied? Your responses might be cast in the form:

That was the first case of

That was the best example of

We had to change our policy or practices after

Our work on was highly regarded by

We learned the most from

New cryptologic employees ought to know about

4. Are there individuals on board or whom you recall from the past as worthy of special study, as role models or as heroes and heroines of "the business," that you would wish to call to our attention? If so, in what capacity? knowledge or files about the instances listed in your response?

Remember to classify appropriately

5. From your own personal observation, what event(s), project(s), or program(s) do you believe best illustrate the support NSA or the cryptologic community has provided to military or civilian decision makers? (This support could be to local- or national-level consumers or even in the international arena.)

6. Conversely, what event(s) provide an example in which NSA or the cryptologic community failed to perform well? Why do you believe that to have been the case?

7. If you have personal knowledge of the cases listed, are you willing to be interviewed by staff of the CCH concerning them or to guide us to other sources?

8. What present or former NSA or SCE personnel can also provide personal knowledge or files about the instances listed in your response?

9. If you have personal files, photographs, or mementos of the cases listed in your response, are you willing to lend them or otherwise make them available to staff of the CCH?

10. From your own observation, what event(s) would you say had the most profound effect on internal NSA or cryptologic community organization, policy, or practice?

 3346

P.L. 86-36

Planning for the Millennium

you can add days, months or years to a date. Most date processing computer programs can add 90 days to 861212 and get 870312, or to 871212 and get 880311 (notice that they are different because of leap year). But not all programs can add 90 days to 991212 and get 000311 (the year 2000 is a leap year). Subtracting days poses the same problem in reverse.

you can compare dates. If you use a straight numeric compare, as most applications do, then 871231 is less than 880101 which is right, but 991231 is greater than 000101, which is not what we want. This situation can adversely affect sorting data in chronological order.

you can convert dates from one form to another. Converting between the ordinal YYDDD format and the calendar YYMMDD format is not a problem because the century is assumed in both forms. (One sidelight: the year 2000 is a leap year but the year 1900 wasn't. So the programs that divide the year by four to see if it is a leap year will convert dates in the year 2000 properly but not dates in the year 1900.)

Note that there are some special cases that conversion programs will not handle properly unless they are fixed, such as a conversion program that assumes the twentieth century; it will not properly convert dates in the twenty-first century to a form that includes the century.

There will be a problem with processing dates in the year 2000 unless it is fixed by then. That is because programmers are allowing only two digits for the year and assume that the century will always be 19**.

At present there are two principal ways we store dates in computer files. One is ordinal, and has the form YYJJJ where YY is the last two digits of the year and JJJ is the number of days since the beginning of the year. For example, February 4, 1988 would be 88035. The other is the calendar date, in the form YYMMDD where YY is the last two digits of the year, MM is the month, and DD is the day. Both forms are convenient for sorting.

The form of the date itself is not a problem. It's when you try to do something with the date in a program, add or subtract days, compare it to another date, or convert it to another form, that presents a problem:

For example, most programs will convert 050505 into "May 5, 1905" not "May 5, 2005". Also, there are some subroutines that will return the day of the week when given a date. For example, 880614 will convert to "Tuesday". As most of these routines assume the twentieth century, they will not return the proper result when given a date in the twenty-first century.

Here are a few applications that may not work in the year 2000 if date processing and calculation routines are not fixed:

- purge data on the basis of its age. Depending on how the routine is written, all data may be purged!
- sort data into chronological order
- calculate a person's age
- run payroll on Friday

One way programmers can avoid some of these problems is to use generalized date-handling macros, most of which should be fixed by the year 2000. One such macro, BDATE, written for The Conversational Monitor System (CMS) on IBM VM systems accommodates the twenty-first century. BDATE uses a base date number representing the number of days since January 1, 1900. This is compatible with the REXX function—REXX is a programming language for the IBM VM systems—DATE(C) except that on January 1, 2000 DATE(C) will revert to 0 while BDATE will continue. BDATE, which can be called up as a CMS command, a REXX function or a REXX subroutine, has the form

BDATE IA <inputs> (STACK

where I defines the form of the input date(s) and A

defines the action to be performed.

- I can be: S for system date and time
 - D for an ordinal date or calendar date
 - T for an ordinal date or calendar date followed by a time (HHMMSS)
 - B for base date and optionally base time (seconds since midnight)
 - A can be: C for convert to base date
 - A for add
 - S for subtract
 - D for difference between two dates
- input

The results (except for difference) will always be the base date, the ordinal date, the calendar date, the day of the week, the month/day/year, the clock time (HHMMSS) and the base time. For an action of D, the result will be the number of days and seconds difference.

For ordinal date or calendar date inputs, BDATE assumes a range of January 1, 1950 (base date 18263) to December 31, 2049 (base date 54787). So 880220 would be February 20, 1988 and 100220 would be February 20, 2010. This will allow calculations that span the centuries and will return the proper day of the week for those days that are in the range. This technique is good for most applications, though some adjustments are necessary for others. For example, ordinal or calendar dates are not adequate as input to routines calculating ages of people born before 1950. The birthdays must be converted to base date.

The base-date technique is one method of fixing

For example, the command:

BDATE DA 871225 10

means add 10 days to December 25, 1987. The result would be:

BDATE	YYMMDD	YYJJJ	DAY	MONTH	DA	YEAR	HHMMSS	BTIME
32145	880104	88004	MONDAY	JANUARY	04	1988	000000	00000

data files that contain ordinal or calendar dates as sort fields. Since a base date is five digits long, the ordinal or calendar date could be converted to base date and stored in the same space as the ordinal or calendar date and the parameters of sort routines will not have to be changed. Another option is to add the century digits to the date (i.e. 19880613 for an calendar date). This would require that the file be expanded by two bytes and that the sort parameters be changed to accommodate the expanded field.

The base date concept used by BDATE is only one technique for solving the date processing dilemma. Programmers must analyze each problem individually and select the best solution for that problem.

Most systems have a time-of-day clock register that programmers can use for date/time processing. IBM 370 series computers have a 64-bit clock incremented so that 1 is added to bit position 51 every microsecond. The 370 assembler and the various compilers each have macros that access this clock. The epoch (date and time when the

clock register would have been zero) has been arbitrarily set by IBM to January 1, 1900 at 0000. With this epoch, the high-order bit was set on May 11, 1971 at approximately 1157 a.m. Unless IBM changes the epoch, the register will overflow sometime in the year 2043.

The problem is not a difficult one to solve but it is pervasive. Most data processing involves a date somewhere. Programmers need to review and correct current processes and also ensure that new systems use date processing techniques that will still work in the twenty-first century.

Question: What is the date of the first day of the twenty-first century?

Answer: January 1, 2001. (not 2000. The year 2000 is the last year of the twentieth century.)

Oops!



To the Editor:

Thank you for printing my letter in VOL XVII, No. 1 of the Cryptolog. I note however, that you twice changed the spelling of the word "pejorative" to "perjorative." This is a common mistake, but it is a mistake nonetheless; there simply is no such word as "perjorative."



P.L. 86-36

File missp From line 1

It's that time of year again, the myriad lists of reassimilees assault all management levels within the Agency. We are asked, once again, to review exhaustive runs of people who are returning from overseas, some of whom have assignments, most do not, etc. Not infrequently during this Springtime ritual, we are admonished from on high by senior management to "give special preference" to overseas returnees. In worst-case scenarios, where a significant number of returnees have not been assigned back at Headquarters, elements are given quotas of how many returnees they will have to absorb. Despite DDA's considerable efforts to manage this problem, it doesn't work, it hasn't worked in decades, and the casualties of the system are those good people who have served this Agency overseas. Maybe it's time we took a different approach.

Consider for a moment who are these people who are returning home. They are some of our best and brightest analysts, collectors, staffers, linguists, or computer types who have risked life, family harmony, and career to serve this Agency overseas. Clearly there are benefits to serving overseas, but each PCS, no matter how glamorous, brings with it the trauma of uprooting family, stresses on relationships, kid's education, etc. The biggest hardship surrounding an overseas tour is the known prospect of having to come back sometime. Most, if not all, of our folks who volunteer for overseas duty do so with an open mind, aware that somewhere downstream they will have to face the agony of the reassimilation process. Yet our people still volunteer to go overseas and the record will show they serve us exceptionally well while detached from Headquarters. This Agency couldn't function nearly as effectively as it does without our overseas civilians. Why, then, when it is so difficult to get some of our best people to go overseas in the first place, do we mistreat them when it's time to come home?

Let's look at the reassimilation process as it now exists. We have, on paper, a system whose objective as stated in PMM 30-2, Chapter 390.8 is to

Reassimilation



David L. Beckner, G05

provide "for rotating personnel from field assignments to positions at NSA/CSS Headquarters." The system is administered by M3, M4, the Executive Assignment Panel, the Senior Personnel Board and the Key Components. The essence of the system is geared to identifying positions for returnees a few months before they are scheduled to rotate home. Overseas individuals are allowed to indicate their preferences of jobs. Then, through some mysterious alchemy, returnees' preferences are (hopefully) married with Key Component's offers and vacancies, and the returnees are informed that they will be given xxx job when they return to Headquarters.

Good in principle; poor in practice. Many marriages of the type described above are made; all too often no offers are forthcoming from the Key Components, and the returnees arrive at Headquarters with no position nailed down, and they join the ranks of the untouchables, those lower class persons who literally walk the halls looking for/awaiting employment. Based on my own personal experience of having been overseas in the 1960's and 1970's, and having returned twice, I can tell you our predecessor systems didn't work very well. Based on the number of reassimilation lists routinely floating across my desk, and my own T/A of the number of GS-15's sitting in the cafeteria at 10:00 in the morning, I've concluded our present system doesn't work either.

So, who's at fault, and how can we make the system work better? First, the employees, the returnees, probably are not at fault. They, in good confidence, took the overseas tour and expect to be re-employed upon their return. It's not their fault the present system doesn't work. Then, it's not M3's fault—they have a "system" which they administer honestly and they really do try to do what's right for the employees and the Agency at large. I contend the fault lies with "management," that mysterious, anonymous, faceless force within the organization that drives the whole system.

Why is it management's fault? There is a relatively obscure label attached to each overseas position that is called "mission element" or ME. Each ME "owns" so many overseas jobs, is responsible for filling those positions, gets a vote on who is selected to fill the positions, gets to vote on promotions of overseas assignees on their ME's, and who, if all else fails, sometimes has to place (?absorb?) returnees once the rest of the "reassimilation process" has failed. Big responsibility. Lots of power. Why, then, is the ME the port of last resort for returnees? M3's most recent PML (No. 15, 27 Oct 1989) states clearly that all returnees who are not assigned to a HQS position will be assigned administratively to their ME, and that the "returnee's specific position will be determined by management of the organization (i.e., ME) to which the returnee is assigned." Finally, somebody is responsible!

My suggestion, a different approach, is to reverse this whole process, make management do its job in the first place, and place the burden (sigh!) on management of placing returnees BEFORE they ever go. That's right, BEFORE they go overseas. Consider for a moment that the ME gets one (of many) vote on who gets selected for overseas tours. That implies that the ME is the gaining organization, that the ME knows the qualifications of the person being selected for the overseas tour, and that the ME has enough confidence in the individual to say "yes" on letting the individual fill the ME's overseas billet.

Or, look at this proposition another way. View it as a contract. We (management or the ME) make a contract with the employee to go overseas for the

Agency, on a ME's billet. The employee also makes a contract to take the tour, to complete it successfully, to get paid, etc. M3 makes a contract to represent the employee while overseas with pay, promotion consideration, etc. L Group makes a contract to ship the employee's household goods overseas, and then back home. It goes on and on. Why not force management, contractually, to send people overseas on its billets AND to have a position waiting for them upon their return from overseas?

My specific proposal is that management, at the precise moment it agrees to sending an employee overseas on its ME billet, also must commit, in writing, what that person's job will be within that same organization upon their return. This approach would solve several problems: It would get M3 and M4 out of the loop (they don't belong, anyway, other than administratively), it would stop the present "reassimilation process" charade we go through each Spring, and most importantly, it would require management to do its job—manage its human resources. It would take some better planning on the part of "management," but that's what managers get paid big bucks for.

My system is not infallible, I know. Some employees wouldn't be happy with their return assignment (most returnees I've known over the years expect to be D/DIR upon their return!), it doesn't account for growth by the employee while overseas, COSC changes, extensions, promotions, or organizational changes within the ME at Headquarters. And maybe my approach won't work with SCEs or STEs; perhaps the Executive Assignment Panel and the Senior Personnel Board need to stay involved at that level. But all of these adjustments could be worked out to management's and the employee's benefit while the employee is overseas, and I, for one, could avoid the annual "reassimilation bugaboo" ritual.

Our people and our reputation as a superb employer deserve better—maybe a new approach is worth trying.

E74

P.L. 86-36

EXCELLENCE
through
EVALUATION

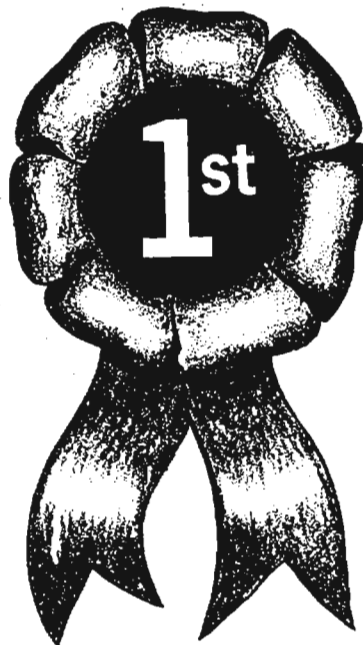

(U) The Evaluation Division (E74) of the National Cryptologic School (NCS) has the job of monitoring the adequacy, relevance, and currentness of training. Its job is an enormous one. In 1989 there were over 700 courses including 200 Learning Center and Extension Services courses delivered at NCS and at fifteen sites throughout the world. Added to this is responsibility for the quality of cryptologic training furnished by the Service Cryptologic Elements (SCEs) whose evaluation methodology they oversee. This challenging task is carried out by 11 people who represent a mix of skills, both operational and academic, which includes a professional statistician and two professional educators as well as analysts, linguists, collectors, training officers, and a computer scientist.

(U) Ever-dwindling resources have led the Evaluation Division to devise smart ways of accomplishing the job with both macro and micro approaches to obtaining continuous feedback on courses. Course evaluations are based in part on responses to machines-scannable questionnaires, one for each learning center or extension courses, and three for each platform course:

- ◆ instructor rating
- ◆ course rating
- ◆ training assessment for student's supervisor

Each form also has a "Comments" section for free-form input in narrative form.

(U) An optical mark scanner scans the forms and automatically enters the data into the database on FLAGSHIP. It flags courses which fall below an acceptable level of performance. Special software compiles statistics in seconds, and allows the Evaluation Division to make various comparisons. For example, students' ratings of a course can be compared with supervisors' rating. Similarly, student ratings of the same course taught by different instructors can be compared. This scheme also permits comparison of ratings by demographic background, such as civilian compared with military, or experienced compared with inexperienced. Above all, it provides verification that courses are meeting their stated objectives and surfaces trends in all categories over several iterations of the course.

~~(FOUO)~~ Data from student questionnaires is only one part of the evaluation mosaic. Another macro

~~CONFIDENTIAL~~

approach is the curriculum review—perhaps the most effective way we have of ascertaining how well a particular course of study is doing. There have been 35 curriculum reviews since the procedure was instituted in 1982. Curricula are selected to be reviewed on the basis of their importance to the Agency's mission and on the date of the last review. Scheduled for review in FY90 are Arabic, Cryptanalysis, Signals Analysis, and Computer Security.

(U) The curriculum review focuses on all courses in a particular discipline. Planning begins about six months before the actual review takes place with the establishment of a working group composed of two or three E74 evaluators and representatives of the teaching department whose curriculum is being reviewed.

(U) First the issues are identified, often with the help of users—Agency elements that are recipients of the training. After the issues are determined, the working group decides on the competencies and perspectives that should be represented on the Review Board. An important criterion for Board members is that they understand future training requirements inherent in technological advances and changing target information. The Board should have the experience and credibility not only to evaluate the relevance and technical adequacy of the current training, but to determine whether the subject is covered comprehensively and to what extent the training impacts on the mission.

(U) A Board consists of five to seven members, headed by a chairman, generally selected from the key component having the greatest need for the courses. The goal is to assemble an unbiased group from NSA operational elements, the military, academia, private industry, and the NSA career professionalization panels.

(U) The Board convenes for four or five days, listening to the teachers and managers who describe their courses and the methodology used. Users from operational areas testify as to user satisfaction with the courses—taking into consideration the structure and sequencing of courses, the quality of the instructional delivery system, the effectiveness of testing,

and the communication between NCS and operations. Users are also asked to address future trends in their target that may affect the curriculum under review.

(U) Then the Board draws up recommendations which it briefs orally to the DDET, followed by a written report. Though the DDET is not obliged to act on these recommendations, past history shows that about 85 percent of them are actually implemented. With DDET approval, recommendations are written up as action items and monitored by the Evaluation Division.

(U) As a result of past curriculum reviews, many far-reaching changes have been effected which have had an influence not only on what the NCS is teaching, but on how it is being taught. For example, the Management Curriculum Review in 1989 encouraged the establishment of a management curriculum for mid-level managers to provide the kind of training which previously had been reserved for senior-level managers and executives—the MD-300 series.

(U) The Education Curriculum Review in 1988 was instrumental in more than doubling the number of courses in the ED curriculum (courses designed to train the trainer) and in the promulgation of NCS Administrative Instruction I-10, the Instructor/Course Manager Evaluation and Development Program. This instruction, patterned after the widely-acclaimed evaluation program used in Fairfax County, prescribed for the first time yearly evaluation of instructors by supervisor or a designated expert, to include classroom observation and a developmental plan for improving the instructor's skills.

(U) Another important initiative which grew out of the 1983 Intelligence Skills Curriculum Review was the establishment of the A Group Training Authority. The chairman of the curriculum review and the then Chief of A2 provided a training authority position as a test case, which soon proved to be an important step to a formal, ongoing line of communication between the NCS and Operations. This position was so successful that the 1986 Target Studies

~~CONFIDENTIAL~~

~~CONFIDENTIAL~~

Curriculum Review Board, of which the A Group Training Authority was a member, proposed training authorities for each Group, thus making training an important part of Group-level management. Today, the Group Training Authorities play a major role in the Curriculum Review process. They nominate candidates to serve as review board members, identify key training issues, provide points of contact to give user testimony, help determine which curricula should be reviewed, assist in the implementation of board recommendations, and identify potential adjunct faculty to assist in the review process.

(U) Some recommendations from curriculum reviews have led to special studies, such as a recent study on prerequisites undertaken by the Evaluation Division to determine the validity of all academic prerequisites. The study resulted in over 150 changes.

(U) In addition there is a mini-review process which includes course validation and revalidation. The initial validation of a course or the pilot evaluation is a look at the first or second offering of a course, examining course content, methods of instruction, and instructional materials. The Evaluation Division looks at methods for assessing student learning such as tests, exercises, projects, papers. It also looks at the results of student evaluations and conducts interviews with instructors, course managers, and students. Revalidation, which parallels the validation process, is used for courses that have been part of the curriculum for a while and have been previously validated. The scheduling of revalidation is based on student enrollment and the amount of time that has elapsed since the last examination of the course. The process of revalidating a course includes interviewing supervisors of course graduates and is conducted in sufficient depth to determine whether a full-scale evaluation is necessary.

(U) A specific evaluation plan is designed in coordination with the teaching department and appropriate operations personnel in order to ensure that the evaluation focuses on the issues of concern.

(C) In addition, the Evaluation Division conducts various research projects, such as managing the evaluation of computer-based courseware for GUESTMASTER.

Another of its larger projects is determining the validity and reliability of 80 to 90 equivalency tests now in use in the NCS. This project is being conducted by evaluation teams composed of professional evaluators, subject-matter experts, teaching department representatives, and a professional statistician who has researched and designed the determinants for test evaluation.

(U) The Evaluation Division is constantly looking for areas where they can make a difference. All of these procedures and programs have one common goal—ensuring quality standards for the NCS.

EO 1.4.(c)
P.L. 86-36

BULLETIN BOARD

GIVING A TALK?

(U) If you plan to use viewgraphs to illustrate your talk, you might want to consult a do-it-yourself packet that contains valuable hints about type face and size, arrangement of contents, and other information to help you prepare legible and appealing viewgraphs. For a copy write to The Editor, CRYPTOLOG, P1, North, giving your name, organization, and building. Please note that telephone requests will not be honored.

CORRECTION

(U) The correct telephone number for *The Cryptologic Quarterly*, now under D91, is 972-2355.

~~CONFIDENTIAL~~

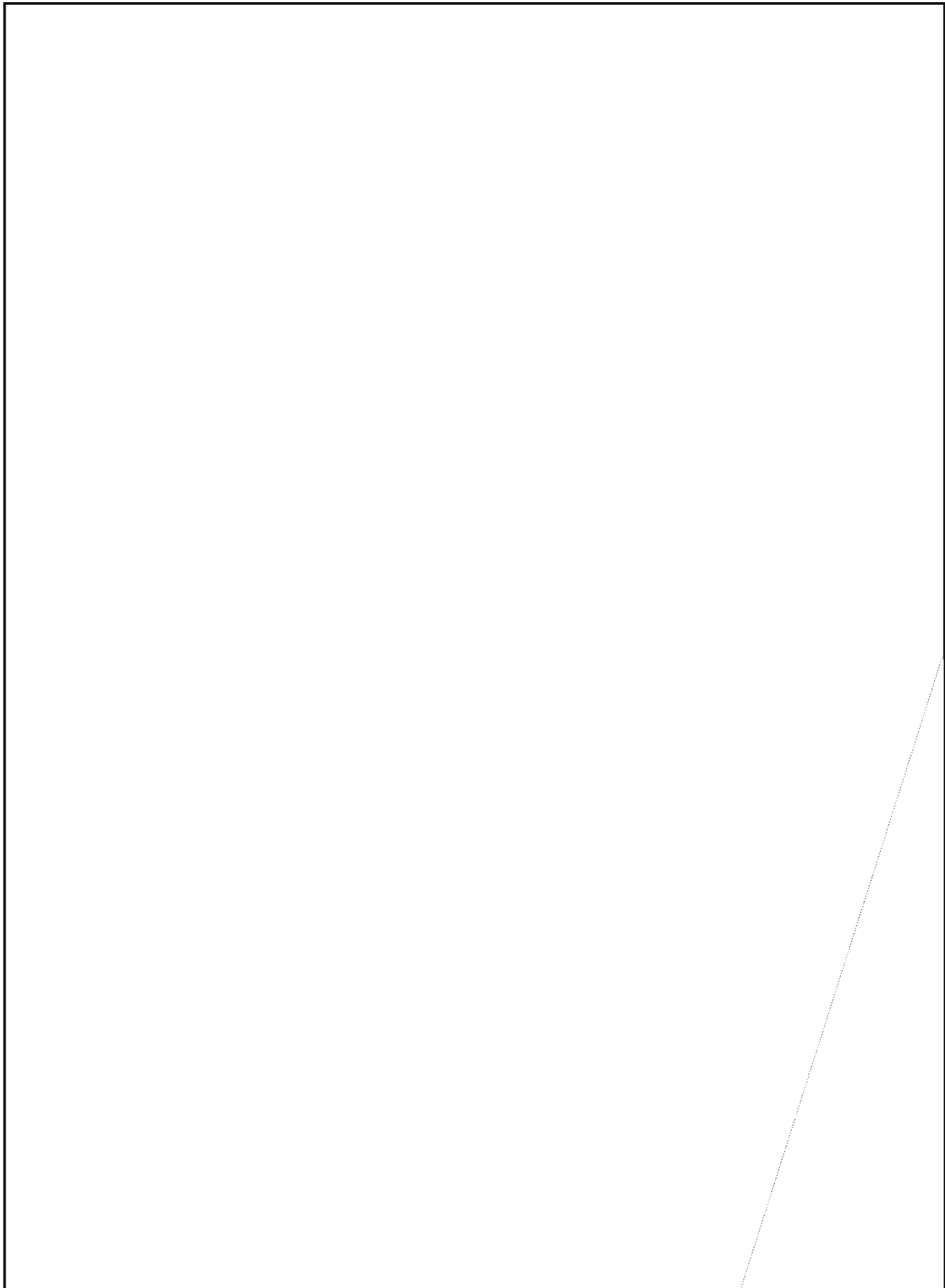



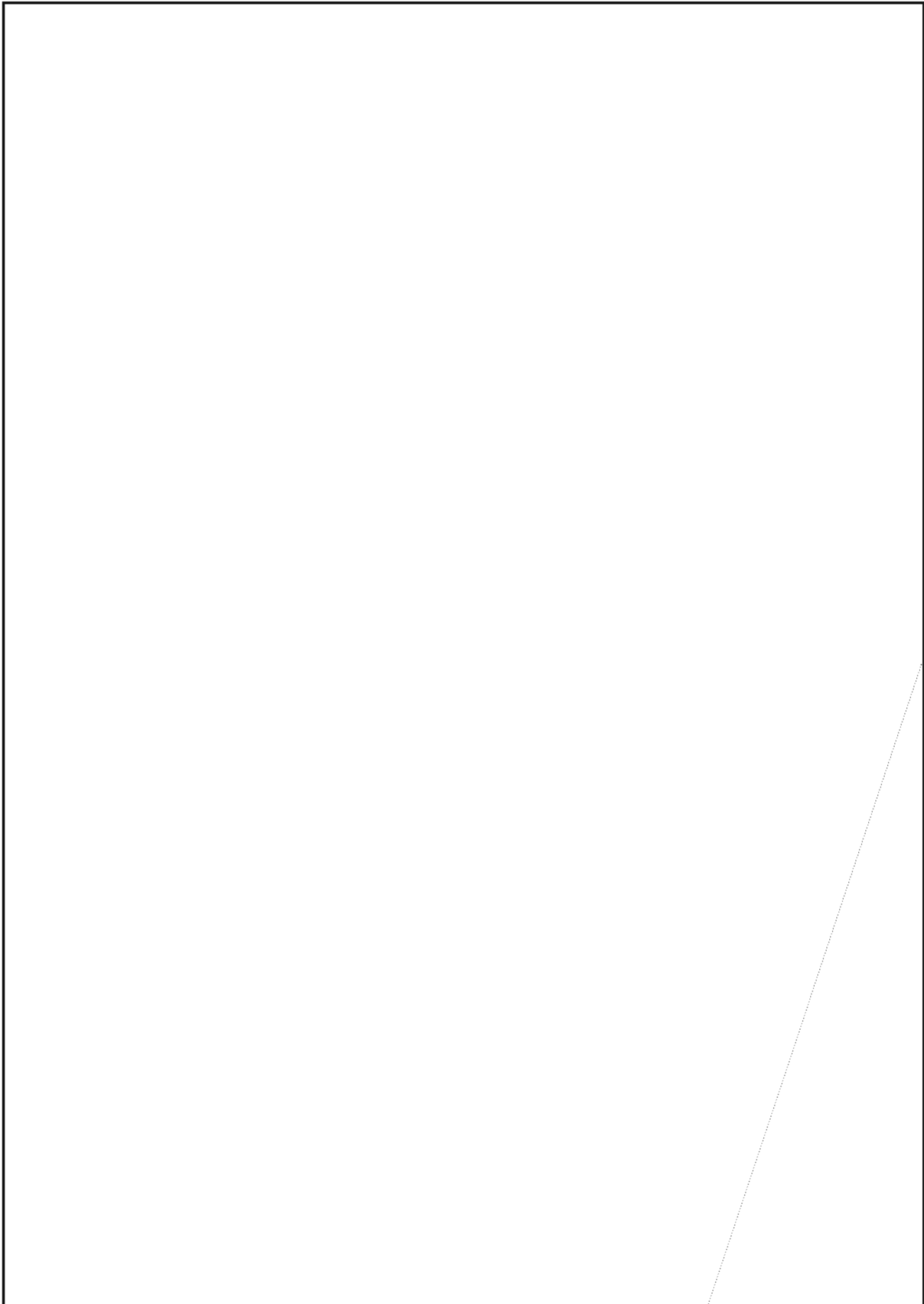

~~SECRET~~

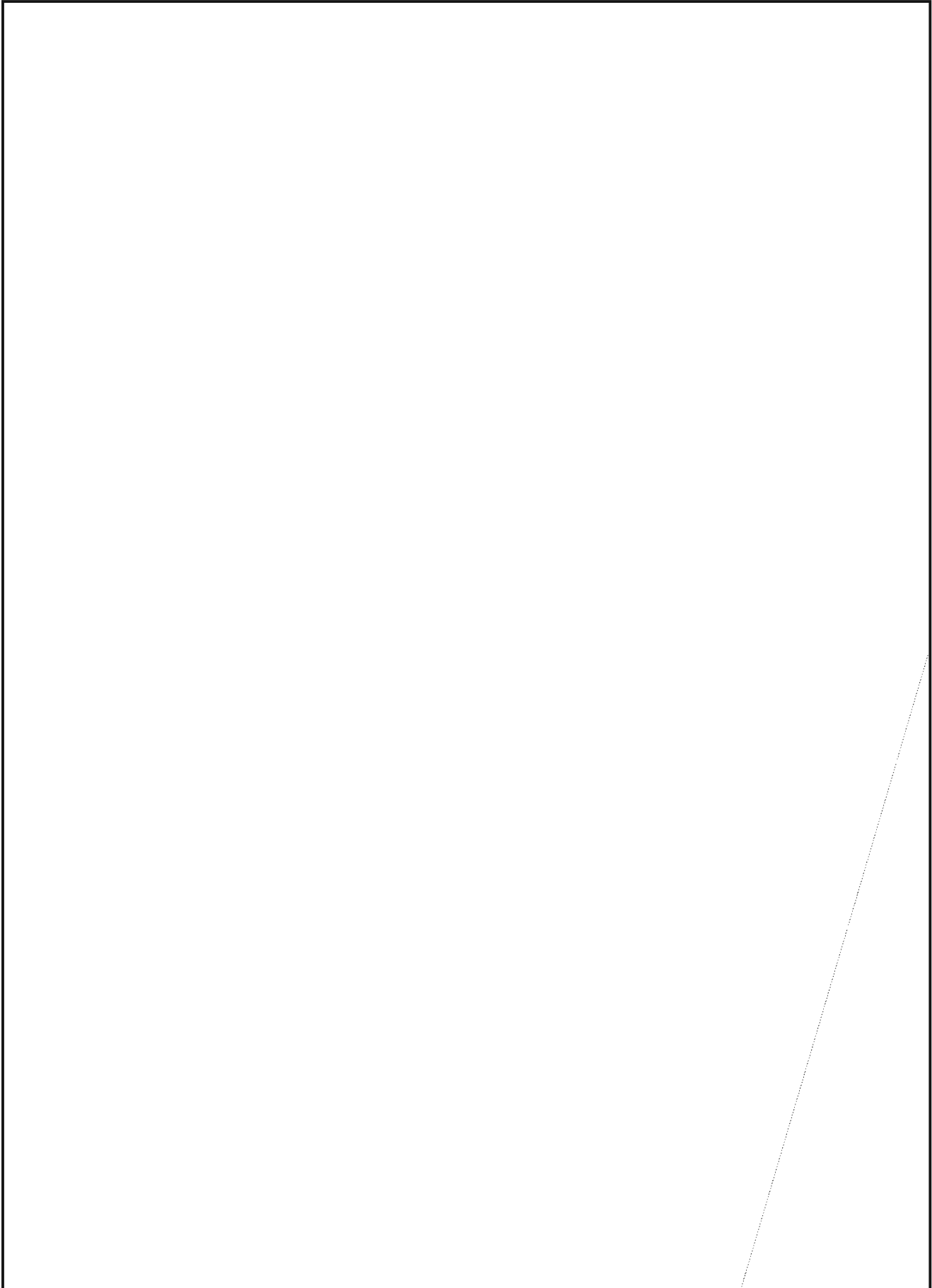

~~SECRET~~

~~HANDLE VIA COMINT CHANNELS ONLY~~

P.L. 86-36
EO 1.4.(c)
EO 1.4.(d)

~~SECRET~~

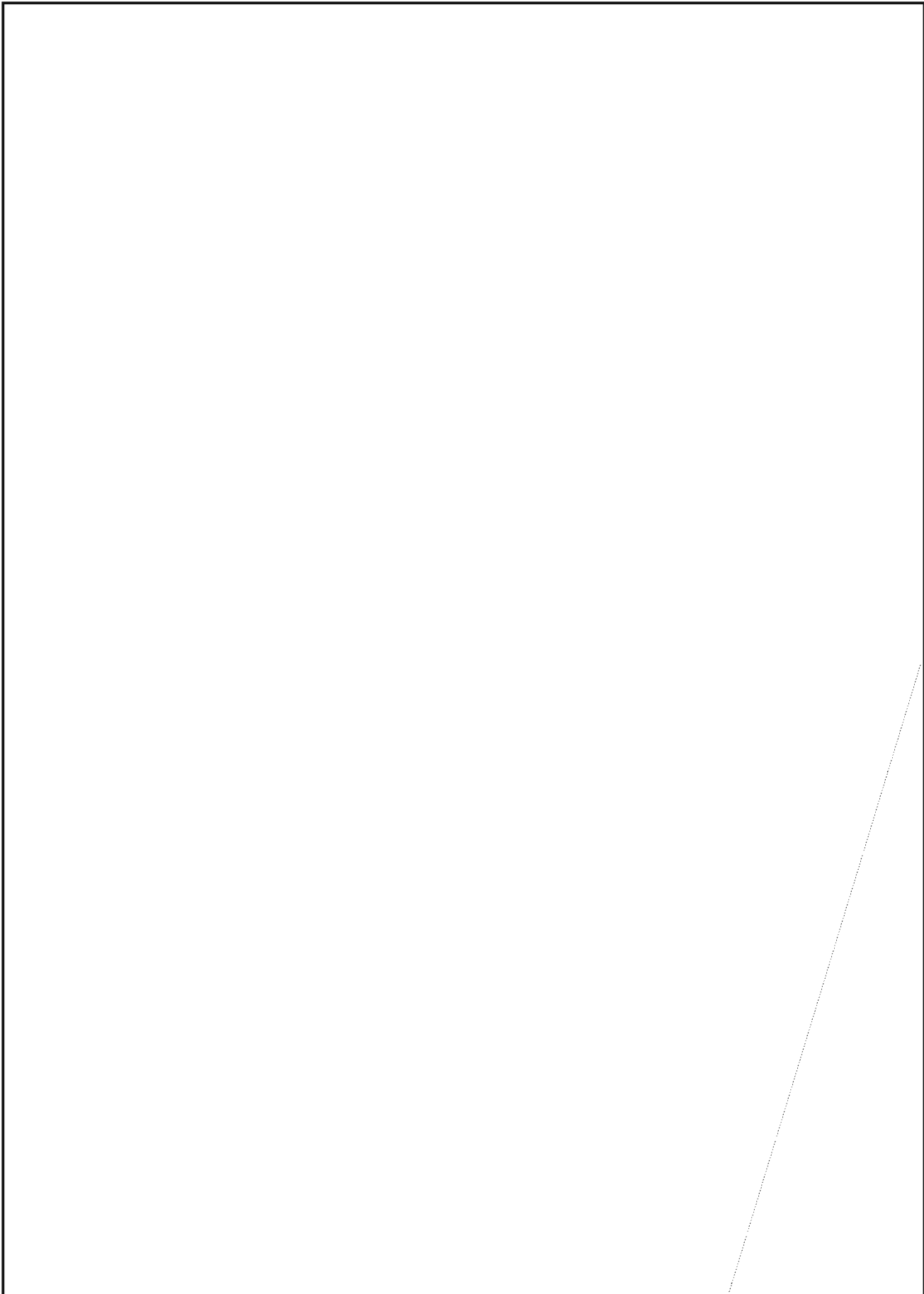

~~SECRET~~

~~HANDLE VIA COMINT CHANNELS ONLY~~

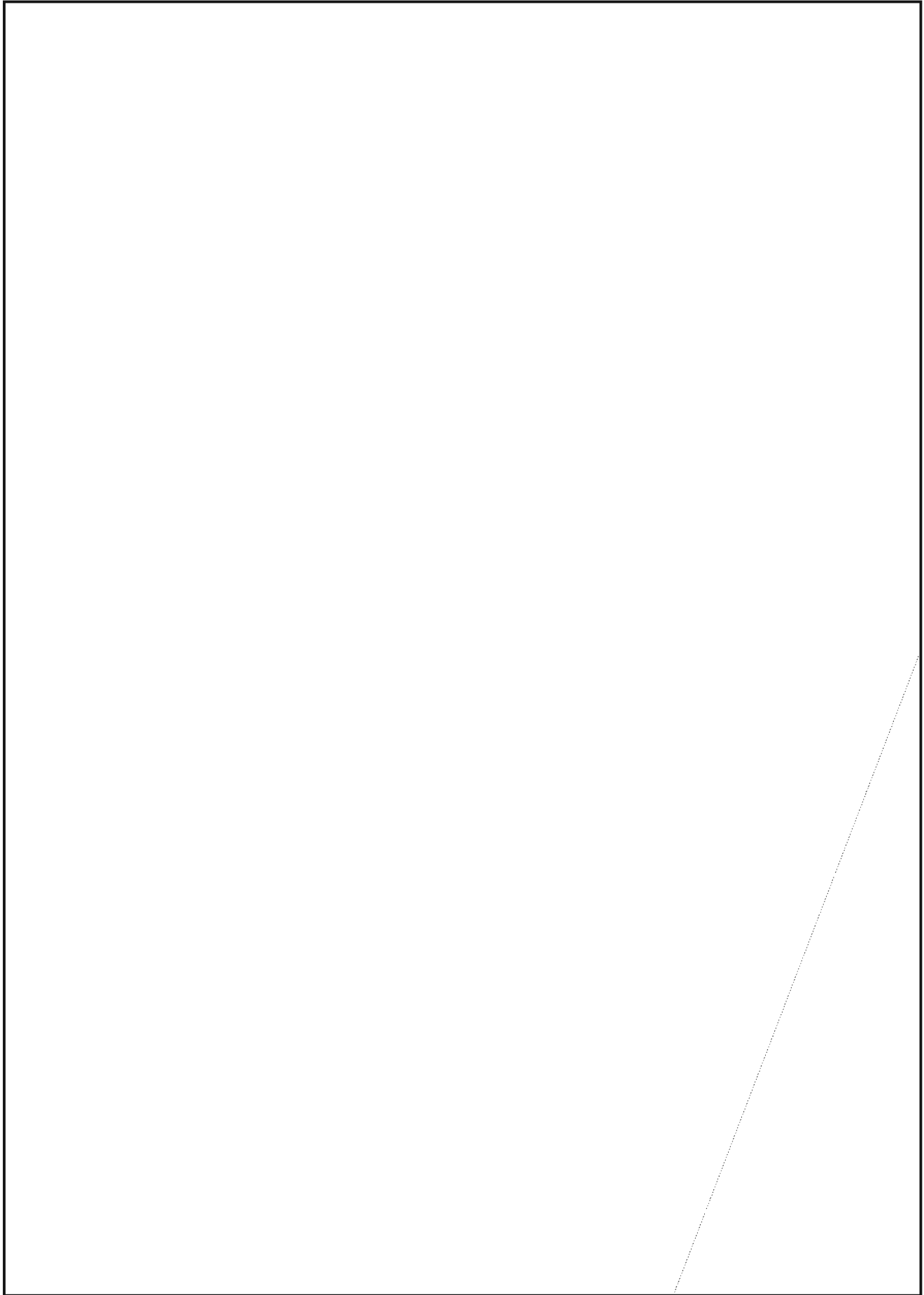

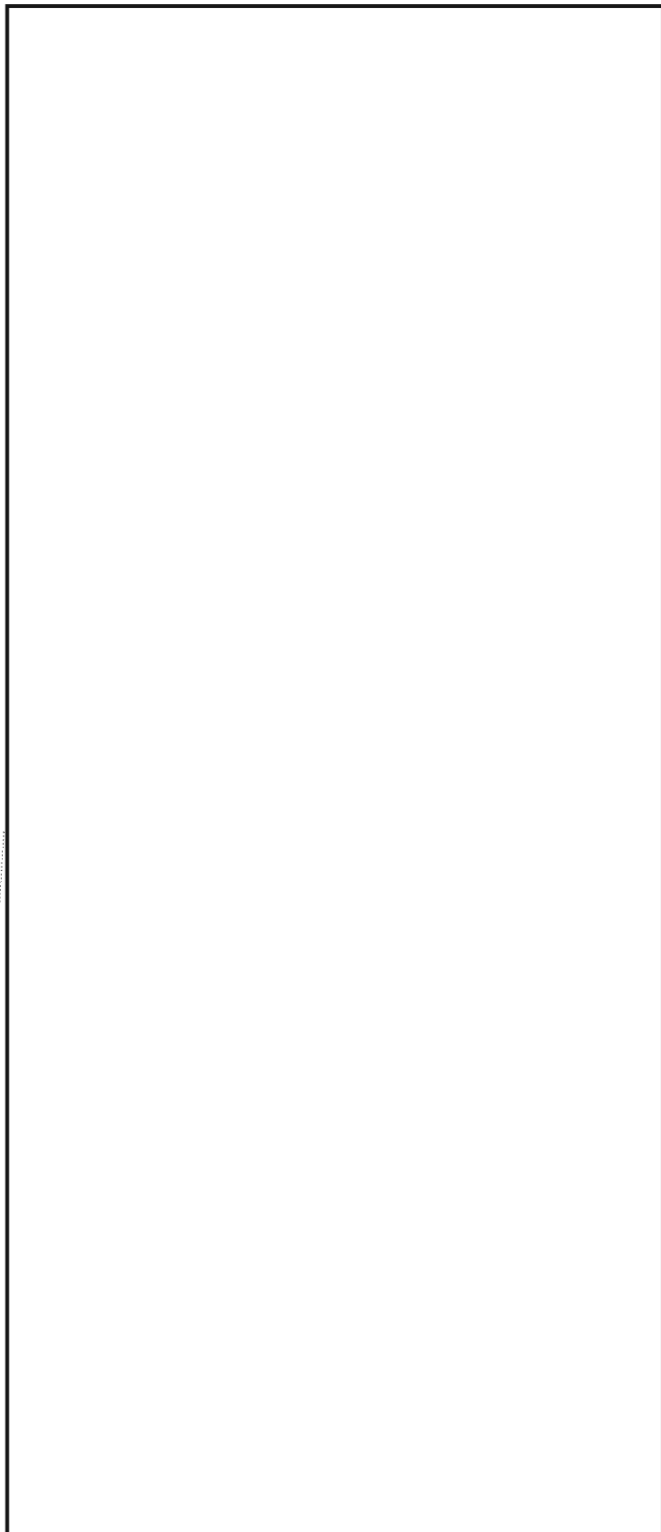

Raw Traffic and Remote Collection

P.L. 86-36

P05/SAO

(U) Following is information on two topics that people have been calling about.

RAW TRAFFIC (U)

(U) A question that frequently arises in the Operations Directorate is, "What is the classification of raw traffic?"

~~(C)~~ Raw traffic, when it does not identify a target country nor reveal evidence of processing is classified CONFIDENTIAL. This pertains only to unprocessed intercept that does not contain operator comments or indications of analytic successes or any reference to case notation or arbitrary traffic designators. This rule applies also to raw traffic intended fo training purposes only.

(U) The classification need not be place on each piece of raw traffic forwarded by courier. But if it is forwarded electrically, the classification, and any applicable caveats, must be placed on the message.

REMOTE COLLECTION (U)

(U) The fact that NSA is involved in remote collection activities when no location or target is identified or inferred has been declassified.

~~(FOUO)~~ When remote collection was a new technology, the sensitivity of the method was protected as CONFIDENTIAL. But because of advance in science and technology, re-moting is certainly a "state-of-the-art" capability and its disclosure should not damage our national security.

(U) Note that this change will be incorporated in the forthcoming revision of the NSA Classification Manual.

P.L. 86-36
EO 1.4.(c)
EO 1.4.(d)

[redacted] R55



EXPERT VLSI DESIGNER HIRED FOR THREE DAYS

We don't know everything there is to know in our office. As a result we need a little help from time to time. Our last call for help brought in an expert from California. Here's how we did it.

Our key VLSI designer, [redacted] is building a special multiplier for processing large numbers. Bob found a new design in the literature that featured high speed with small physical size. This design is complex, consisting of several pieces that are best visualized in three dimensions. Pictures show only two dimensions, so . . . help!

The author of the design was Dr. Mark Santoro at Stanford University. A call to the University led to a call to Dr. Santoro, who is no longer on the faculty at Stanford, but who agreed to visit and consult on the multiplier, for a fee, of course!

Fee payment for consulting services is something Bob has done before. He arranged with [redacted] our L4 contracting officer, to hire Dr. Santoro through Consumer Sensory Products Corporation, an occasional employer of Dr. Santoro. Since the cost was less than \$5000, the PR was processed, with the help of [redacted] in less than a week.

An interesting sideline is that the telephone conversation between our [redacted] and Dr. Santoro was so clear that Dr. Santoro thought we were a local Bay Area company. He accepted our invitation before he realized we were across the nation and not across the Bay. Nevertheless he was on the airplane to the east a few days later.

Dr. Santoro was put to work. In the three days he was here, he gave one briefing to R55, another to R1, and still another to V75. After the briefings Dr. Santoro sat at the workstation with Bob and designed two arrays using the new architecture. The effort produced a family of multiplier designs useful to R5, V7, and R1.

The result is that for a modest expenditure and in a short time we were able to get expert help, all with an ordinary purchase request. As bureaucratic as it sometimes seems, our procurement system can be used in ways that are beneficial to our in-house designers.

We called on expert help, and within a short time, we got it!

Rebuttal

P.L. 86-36



P.L. 86-36

(U) A number of us "fallen away" linguists feel compelled to correct what we believe are definite misimpressions given in the last issue's article "A Note on the Linguist Problem." We believe Mr. [redacted] article was an honest attempt to address a perceived problem afflicting the language career field, but we also believe that his basic assumptions are incorrect.

(U) He maintains that there is general agreement on two issues: a shortage of qualified linguists and the fact that linguists leave the field because of a lack of promotion opportunities. While there have traditionally been critical shortages in certain (usually low-density) languages, and while not all linguists (qualified or otherwise) are working in the language career field, the far-reaching statement that there is a shortage of linguists may no longer be true.

(U) With respect to his second assertion, which is the focus of this response, we believe that linguists leave the language field for many reasons, only one of which is promotional considerations. In fact, promotions are probably the least important reason considering the real effort now to promote non-supervisors. One only needs to look at statistics in the latest QMR to discover how untrue is the assertion that one has to be a supervisor to get promoted. Linguists of the younger generation, especially, probably leave not so much for monetary reasons but for personal development. Let us present a few more plausible reasons why some

linguists, including the writers of this rebuttal, have left the field.

(U) Linguists leave because they are bored and because they want more challenge than that offered by many language jobs. It is important to understand that not all individuals classified by their job duties as "linguists" love languages enough to make a career of them. Many "linguists" happened to have learned languages in pursuit of area or social studies degrees where languages were a mandatory part of the program. Even language majors were often more interested in the literature, culture, and history of the people who speak the language than in the language itself. These individuals have many other interests besides translating and transcribing.

(U) This brings us directly to another important reason linguists leave, namely the desire to use on the job other skills which they may possess and to develop additional skills or areas of interest. Such skills may include public speaking, political skills, public relations, teaching, representation, writing, and management. While many of these skills can be employed in some areas where linguists work, these skills are more heavily applied in management and staff positions. The diversity of skill usage that such positions offer is very attractive to those who want to exercise or employ as many of their abilities as possible in the process of fully developing themselves and their careers.

(U) A number of years ago it was not unusual to have linguists leave the Agency, not just the career field, because their language skills were so critical that they were not allowed to do anything else. Promotion was not an issue; personal development and job satisfaction were. Even today, many linguists who love language work are frustrated because they see little hope of advancement (read: increased responsibility and challenge — not just promotion) if they stay.

(U) There are any number of negative forces at work that also drive linguists from language work. Every year many very good linguists reluctantly leave the career field because of an inability to pass the relevant language PQE. No one likes to hear this, but perfectly good linguists doing valuable work in their organizations leave because they are tired of banging their heads against the PQE system. We must also mention the linguists who leave because of the "sweat shop" atmospheres that prevail (yes, even in 1990) in their work areas—this includes lousy and overcrowded working conditions as well as the often unchallenging and repetitive, albeit important, language work.

(FOUO) [redacted] assumes that it is always a negative when linguists leave the field. We would like to suggest, however, that there are some good things that happen both for the Agency and the persons leaving. The Agency benefits immensely from the cross-fertilization that occurs when linguists work in areas other than DDO. On the one hand, linguists get exposure to the enormous problems and efforts involved in making it possible for linguists to have something to work on. Frequently, their expertise in operations helps those in support areas get a better perspective on how to handle requests for new products, services or improvements to existing support structures. On the other hand, people in support areas get a better perspective from these ex-linguists on what all their work amounts to in the operational arena. Those working in support areas outside DDO sometimes have little idea of how their work contributes to intelligence collection and processing. Even within DDO, former linguists have been known to bring valuable insights to the solution of a problem because of their particular expertise. Indeed, in the collection

and processing fields, a first-hand knowledge of language or "analytic" skills often makes the solution more rapid AND more appropriate.

(U) Additionally, linguists, because of their facility with languages, tend to be good communicators. This is one area where "fallen away" linguists make critical contributions. There are several staffs in the agency (Q,J,N, for example) that devote much time to defending the Agency from those downtown who would chip away at, or steal outright, our mission, function, and even life's blood (i.e., budget). Many of these battles are ultimately won because we can state our case clearly and convincingly and many of these cases are written by ex-linguists.

P.L. 86-36

(C-CCO) [redacted] seminal article raises other questions that need to be answered, such as: Is the failure to establish viable tech track programs the real reason linguists leave? or What is the real value of staff work to this Agency? or Is it realistic to expect linguists to conduct customer relations, collection management and still have time to process intercepted communications? (NOTE: We take strong exception to many of the author's other assumptions and conclusions, but will leave those topics to others to examine more fully.)

(FOUO) We also suggest that this issue is not unique to linguists, but rather raises the broader question of individual growth versus organizational requirements. The author suggests that we collect and decrypt more than we can publish because we lack linguists. How much more could we collect and decrypt if we had more engineers, signals analysts, and programmers?

(U) Any attempt to solve the problem of linguists leaving the career field, if indeed there really is a problem worth solving, must take into account all the reasons for which linguists leave. While we do not pretend a comprehensive approach, we hope the perspectives we have just offered help establish a more complete and correct picture.

*Asian Parasite Threatens Bee Population
Italian Expedition Stakes Claim in Antarctica
AIDS Information Campaign Extended to
Schools
Alcoholism Statistics Worse Than Expected
Quality of Teaching Profession Criticized
Alitalia Increases Capital; Plans Expansion*

~~(S-CCO)~~ These are just some of the subjects I've translated from Italian newspapers and magazines as a contract translator over the past few years

When I moved to my current liaison position at CIA HQS, the job promised new challenges, broader experiences, new perspectives, my own IBM XT, even a work-related parking sticker, but no translating. I wasn't keen on having my language skills slowly rust away from disuse, so I looked for some other way to maintain them, as my use of Italian outside of work was minimal. Freelance translating seemed the logical answer.

~~(FOUO)~~ Since I was on assignment to CIA, it was relatively easy to research its translation service. The US Joint Publications Research Service (JPRS) is a component of the Foreign Broadcast Information Service (FBIS) located in Reston, Virginia. FBIS, an overt operation which falls under CIA's Directorate of Science and Technology, collects and scans over 7,000 foreign newspapers and publications for material to be translated in response to Community requirements. It publishes the more perishable items (radio and TV broadcasts or press reports, for example) in eight FBIS Daily Reports, and passes the less perishable items (newspaper and journal articles, for example) to JPRS for publication as reports.

~~(FOUO)~~ Well, it sounded as if it had possibilities. So I wrote JPRS, and received an application form, background information form, and a language examination to do at home. The two forms were a couple pages of routine questions on background and experience that I submitted to Q4 for review. The language examination consisted of translating two articles—one economic,

Short-Order Translation



P.L. 86-36

[Redacted] T5

the other technical—into "clear and idiomatic English." Once the paperwork was completed, acceptance came in the form of a contract.

(U) Soon after, my Desk Officer sent a welcoming letter and a copy of the *JPRS Handbook for Contractors*, containing complete instructions for handling translation assignments. The Desk Officer, I learned, is the contractor's lifeline to JPRS. She sends assignments, supplies, newsletters and working aids. She also reviews and edits translations for publication, evaluates quality and timeliness of translations as part of the periodic evaluation process and stands ready to answer any questions.

(U) Assignments are made on the basis of qualifications, areas of expertise, and ability to meet deadlines. The goal of FBIS is to get the work translated as quickly and accurately as possible, so it's important that translators keep the Desk Officer informed of the number of words they can

Working Aids

~~(FOUO)~~ NSA is on distribution for all of the working aids mentioned. T5152 handles internal NSA dissemination and the Reference Section of the Main Library has them all on microfiche. Hard copies of the more recent ones can be ordered through T5152.

(U) The most current list of titles and document numbers can be found in the 1989 Dictionary Issue of *No Uncertain Terms, Terminology Guide for Translators*, another excellent working aid. This bi-monthly publication provides information and guidance to JPRS translators. The publication, containing a wealth of information, is an open forum for any topic related to translating or terminology.

(U) The yearly Dictionary Issue is a compilation of those dictionaries and reference books considered essential for FBIS translations. One section of *No Uncertain Terms* is usually reserved for FBIS Standardization Decisions, such as ~~FBIS rulings on the expansion of acronyms, translation of terms, correct spellings, and so on.~~ It supplements the standardization rules spelled out in the *Handbook* and other working aids mentioned above.

translate each month, and also of any changes in their availability to translate. Since it has no control over the amount received, JPRS can give no guarantees on volume of work to be assigned.

~~(FOUO)~~ To help the translator JPRS provides several working aids. JPRS publishes many very good glossaries and reference aids on acronyms, abbreviations and specialized terminology. Occasionally it conducts workshops for translators. Technical support is just a phone call away. With regard to automation support, there's the monthly *Newsletter for JPRS Contractors* which provides guidance on putting finished translations into proper software format. There's also the *Automation Guidelines for JPRS Contractors*; an instruction handbook for doing translations on computer. And of course, the Desk Office is always willing to help translator with questions.

~~(FOUO)~~ Returned assignments are edited and published in about 50 serial reports and ad hoc publications. Most reports are published in two versions: a FOR OFFICIAL USE ONLY version containing material covered by copyright restrictions and distributed to U.S. government consumers only; and an unclassified version containing non-copyrighted material, distributed to US Government consumers and also on sale to the public through the National Technical Information Service.

(U) JPRS contracts about 1,000 translators, who do not require US citizenship, to handle the unclassified translations—classified translations are done inhouse for the most part. Independent contractors receive assignments by mail, do their translating at home, and are paid according to a schedule of rates per thousand words translated. Rates are established based on such factors as specialized skills and type of language: selected Asian and East European languages and special technical expertise earn a premium rate.

(U) A new computer editing and composition system was introduced in 1987. The Automated FBIS System, as it is called, requires that all translations be in electronic form. As a result, close to 95 percent of the contractors now do their translating on computer and submit work on diskettes or via modem.

(U) If you're interested in contract translation, JPRS currently needs *experienced* translators in the following languages: Arabic, Cambodian, Chinese, Czech, Slovak, Finnish, Hungarian, Icelandic, Italian, Japanese, Korean, Latvian, Lithuanian, Turkish and Ukrainian. Applications from translators with a knowledge of uncommon languages, such as Kirghiz or Swahili, are always welcome. Applicants should have a good command of written English and should be able to submit translations on computer disk. To apply, send a resume (after Q4 has seen it) to FBIS/JPRS, P.O. Box 2604, Washington D.C. 20013.

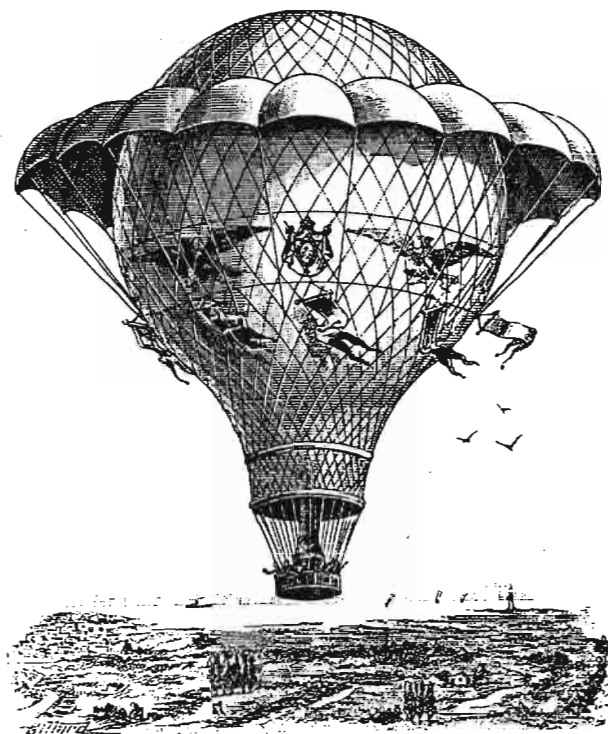

BALLOON-INT. CIVIL WAR STYLE

Today's arcane business of airborne and spaceborne intelligence gathering is a multi-billion dollar industry. However, as complex and as high-tech as it is in today's world, airborne intelligence gathering had a rather simple beginning—during the American Civil War. The Union and Confederates both used hot-air and later, hydrogen-filled balloons to spy on each other. Even back then field commanders were keenly aware of the lack of and the importance of real-time, reliable information on the enemy's intentions, whereabouts, and movements. Observing the enemy from balloons filled some of those information gaps.

Balloons were not new in the US in the 1860's; in fact, they had been known in this country since their first flight here in 1793. Shortly after the outbreak of the Civil War, balloonists, or aeronauts as they then liked to be called, volunteered their services and their balloons. Perhaps the most famous of these was Professor Thaddeus Lowe, who although he was only 28 years old at the time, had been involved in the science of ballooning for years before the War. In July 1861 Lowe arranged a demonstration of

ballooning for President Lincoln and the War Department. At an altitude of 1,000 feet over Washington DC he used the insulated wire anchoring his balloon to telegraph a message to Lincoln saying that from his observation point he commanded a view of over 50 square miles of area. This telegraph message was the first ever sent from a balloon. Thus was born the downlink—albeit an unencrypted one, but a downlink nonetheless. President Lincoln, impressed by Lowe's demonstration, asked him to form a balloon observation corps and authorized funding and personnel for five balloons and ground support crews.

In an effort to sell the President and War Department on the new balloon technology, Professor Lowe probably stretched the truth and overstated its capability when he told Lincoln that he could see a 50 square mile area, because in actual operations a balloon observer, with the aid of a telescope, could realistically cover an area of about 30 square miles. Once they were put into service and after some trial and error the balloons were equipped with several miles of insulated telgraph wire, signal flags, and searchlights for nighttime use. The insulated wire

and signal flags were key additions to the inventory since the any information gathered was not worth much if it could not be quickly communicated to the field commanders. The observers soon became adept at counting tents to get estimates of troop strengths and using enemy campfires to spot locations. Surveyors and mapmakers also rode balloons as observers and used the first-hand information they gathered to make detailed maps of terrain features and troop locations for the local ground commanders.

There were however, limitations to the usefulness of Balloon-INT much as there is with modern airborne intelligence gathering methods. Weather was a big determining factor on the balloon missions. Even when the balloons could fly, sometimes the smoke and dust of the battlefield limited or entirely negated the usefulness of the observers. Realizing that being under Union observation made them very vulnerable, the Confederates, like today's armies, learned to deal with the threat. The Rebels became very adept at deception and camouflage—sort of if you can't join them, beat them. They constructed fake gun emplacements and cannons, and put out the fires in their camps or set campfires in dummy camps to confuse the observers. Another tactic they adopted was to make important troop movements at night. Although these measures did confuse the balloon observers, they also cost the Confederates dearly in manpower, time and ease and speed of troop movements

The Union learned just how valuable airborne intelligence gathering, coupled with real-time relay of information, could be during the battle of Fair Oaks (May 31- 1 June 1862). On the first day of the battle Professor Lowe himself was aloft and observed a large concentration of Confederates massing for an assault. His telegraphed information enabled the Union forces to quickly bring up reinforcements and stave off the advance. On the second day, ascending to an altitude of over 2,000 feet over the battlefield and trailing over a mile and a half of telegraph wire, Lowe used an on-board operator to relay situation reports every 15 minutes directly to the "ground station" where President Lincoln was located. It is generally conceded that in the battle of Fair Oaks the fact that balloons were able to make observations and relay them in real-time to the ground did much to avert a

stunning Union defeat. Professor Lowe and his balloons played an important role in the Union actions at Fair Oaks. Little did he or anyone else know just how important this battle would be or the effect it would have on the rest of the war. For it was in this battle that the Confederate General Johnston would be twice wounded and have to removed from command. In his place President Jefferson Davis put Robert E. Lee in command of the Army of Northern Virginia—which he held until the surrender at Appomatox in April 1865.

Balloon-INT, like any other INT, has its share of amusing war stories. One such story shows just how important serendipity can be to a good intelligence gathering operation. Richard Wheeler, in his book *Sword over Richmond* which chronicles Gen. McClellan's Peninsula Campaign of 1862, gives an amusing account of an unplanned intelligence collection mission by one of the Union generals. It seems that Professor Lowe had been giving balloon lessons to Gen. Fitz John Porter. On 11 April Gen. Porter decided to make a dawn ascent in one of Lowe's balloons. According to the account, the single rope tethering the balloon snapped like "an explosion from a shell" sending the general and the balloon on an unintended free flight

With Lowe trying to shout instructions up to the general, the balloon began to drift toward the Confederate lines. Gen. Porter then tried to climb the balloon's outer netting to reach the safety valve release rope. Failing in this, he is reported to have calmly climbed down the netting, pull out a spyglass from the gondola and begin reconnoitering the enemy positions. At this point the winds aloft freshened carrying the balloon, Gen. Porter and his spyglass over the Confederate lines deep into enemy territory. While the Rebels tried in vain with their muskets to bring down the balloon, Gen. Porter calmly continued gathering intelligence. For some time the balloon drifted to and fro over the battle front under the helpless gazes of both sides. Finally, the balloon drifted back over the Union side and this time the general was successful in reaching the safety valve rope

and the balloon landed safely in Union hands. After a rather harrowing experience the general had indeed gotten more than he had bargained for. He got his first-hand, real-time intelligence and an adventuresome flight to boot. Upon hearing of General Porter's adventure, Gen. McClellan, who was Commander of the Army of the Potomac at that time, said that he wouldn't be caught "in one of those confounded balloons . . ." and would not allow any of his generals to go up in them.

Lowe is even credited with creating the forerunner of the aircraft carrier. Quick to realize that mobility and being able to keep pace with the tactical forces he was supporting were important, he developed a riverborne capability. He had a former coal barge converted to a floating balloon support station. Using this vessel he was able to fly his balloons high above the tether ship and be towed up and down waterways making continuous observations over a wider area.

While it is true that in the field of Balloon-INT the Union may have had the upper hand, it wasn't all one-sided. The Confederates realized, probably more so than the Union, the value of balloons for gathering information, and tried their luck. However, like so many things the Confederates tried, the only luck they had was bad luck. Their first attempt in 1861 to build and launch a balloon was an absolute failure. They tried again in June 1862 and were successful. This balloon, tethered to a tug in the James river, was one day left high and dry by the outgoing tide. The Union troops were able to capture the vessel and reel in the stranded balloon. Short of funds for such "experiments," the Rebels were not able to field a third balloon until 1863. In the summer of that year that balloon was blown from its tether by high winds, drifted over the Union lines and was confiscated. This was the last attempt by the South to use balloons in the War, though I believe that Southern generals would have been more willing than their Union counterparts to use observation balloons as part of their operations had funding been available.

Lowe, like many other visionaries, was not fully understood nor completely appreciated by those in power. Early in the war he enjoyed the active support of generals such as McClellan and Porter, but those who succeeded them in the Army of the Potomac were not as far sighted. His new superiors, not sensing the importance of his work, had placed what Lowe saw as unbearable restrictions on his operations, and they had also cut his funding and ground crew support. Lowe became disenchanted and resigned in May 1863. After his resignation his balloon corps died and with it the means to provide real-time intelligence support to ground forces. It would be almost 60 years, during World War I, before U.S. military forces would once again look to airborne intelligence gathering to support tactical operations. One can only imagine what changes would have been made in the histories of such battles as Gettysburg, the Wilderness, Chancellorsville and others had observation balloons and airborne intelligence gathering and real-time information relay continued to evolve.

In today's high-tech intelligence gathering business, the concepts that are second nature to us such as downlinks, ground stations, real-time data relay, support to tactical commanders, camouflage and deception all had their beginnings back in the Civil War. We have refined these concepts to a very high degree using video and digital technology, lasers, spacecraft, etc., but Professor Lowe and his balloons started it all.

By way of giving credit where credit is due, the least we can do is name our next high-tech, multi-billion dollar airborne intelligence gathering system after him.

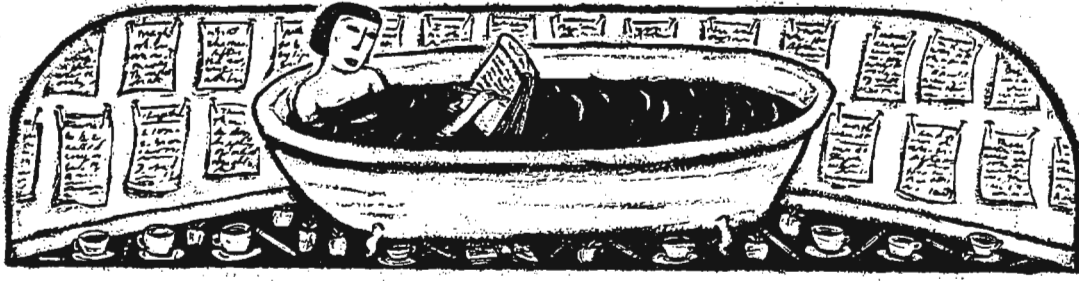

To the Editor:

I feel that [redacted] letter to the editor concerning the Multi-Disciplined Analyst Program (1st Issue 1990) betrays a misunderstanding of the program, and perhaps a flawed perception of the purpose of education and training in general. CK-600 is the current incarnation of the Multi-Disciplined program, and the first class, of which I am a member, will graduate in October 1990. At no time before or during my involvement in the program have I been so "naive" as to think that NSA would pay my salary for two years—two years in which I could contribute little to NSA's mission—simply to "enhance my career." I don't mean to say that the agency isn't interested in personal development, but business is business, and businesses invest in education and training because they expect some return. The Multi-Disciplined Analyst Program hopes to produce a set of employees equipped with in-depth knowledge of SIGINT collection, processing, and analysis. It wasn't created to boost the careers of the participants.

[redacted] letter reflects a common misconception about "career-enhancing" programs, including intern programs. NSA is in the business of producing signals intelligence and protecting U.S. communications; NSA is not in the business of making careers. A person's career is his or her own responsibility. Every employee should know that when an employer tells you, "This program will benefit your career," what is actually meant is, "This program will make you a more useful employee." And here's an important tip: being a more useful employee will benefit your career. What you write in your personnel summary is irrelevant if you don't use your background to further NSA's mission.

As far as the advertising hoopla about "technical leaders of tomorrow" goes, I hope the future applicants to CK-600 are analytically sophisticated enough to separate advertisement from fact. Anyone who has ever been in a gathering of interns has heard an agency senior say to a room full of people he or she doesn't know, "You are the future leaders of this agency—the movers and shakers." Any time you hear that sentiment expressed, take a look around you and imagine the people you see as agency leaders. Makes you shake and want to move, doesn't it?

The only thing an education and training program (such as CK-600) can do is increase a person's knowledge. If a person puts that knowledge to the right use, then yes, he or she may well become a technical leader; it's a worthy goal. But you cannot identify a person as a leader by looking at his or her personnel summary. I hope the agency never takes action to "enhance the careers of multi-disciplined people," or of anyone else, for that matter. Basing promotions on "tickets punched" is not good management. The only acceptable measure of an employee is job performance, and if an education and training program improves your job performance, then you're well on the way to enhancing your own career.

I would encourage anyone who is interested to pursue the CK-600 program, because I believe the agency needs people with the background this course provides. Plus, as long as you're interested in meeting that need and not just in filling out a persum, it could make you a more useful employee.

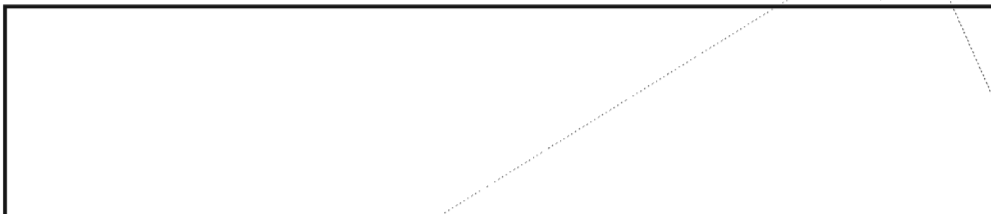

To the Editor

Re:  article "A Note on the Linguist Problem" in the 1st 1990 issue.

1. For Techtrackers:

```
#####
# This UNIX shell script explains the abysmal #
# state of the Agency's SIGINT technical health. #
#####
sed '/Linguists/s//TAs/' article > TAarticle
# String "Linguist" in article is changed to "TA" in TAarticle
cat << ! >> TAarticle
```

EO-1.4.(c)

~~(S-CCO)~~



As a group, Traffic Analysts have about one chance in 10 of getting to BB14, less than one chance in 100 of making BB15, and little chance of making STE. For actual working TAs, statistics are much worse: about one in 20, less than one in 400, and nonexistent, respectively. Unfortunately for the Agency, the best and brightest TAs can and do analyze things besides communications. Things like promotion stats, job opportunities, and BS&M (blue smoke and mirrors, aka Techtrack).

```
!
# Adds additional paragraph to TAarticle.
cat #article > poortechhealth
# Combines articles on linguists, TAs, IRs, SAs, SCs, Cms, etc
# into a single report very appropriately named poortechhealth
read poortechhealth
# Management reads report on technical health of the SIGINT
# workforce (the folks who actually produce SIGINT and pay
# the light bill here).
echo "We will do more for our technical people, etc, etc."
# After upper management review, the usual action is taken.
# More words are sent forth to pacify the technical rabble
# while another 50 "fast tracker" managers, staff turkeys,
# and other strap hangers are quickly promoted.
mv poortechhealth /dev/null
# Management moves combined report on poor tech health to the
# current location of Techtrack.
find / -name managementjob -print
# Techtracker, after hearing the same old words, seeing the
# action taken, and checking the latest promotion list,
# locates and prints out a listing of management jobs.
cd /management/newjob
# Techtracker finds the real answer to personal advancement.
haltsys
# What BG&E does when you don't pay the light bill.

#####
# End shell script
#####
```

2. For all others:

The gist of the above: "Actions speak louder than words", "As ye sow, so shall ye reap", and BG&E has a solution.

 P14

~~SECRET~~

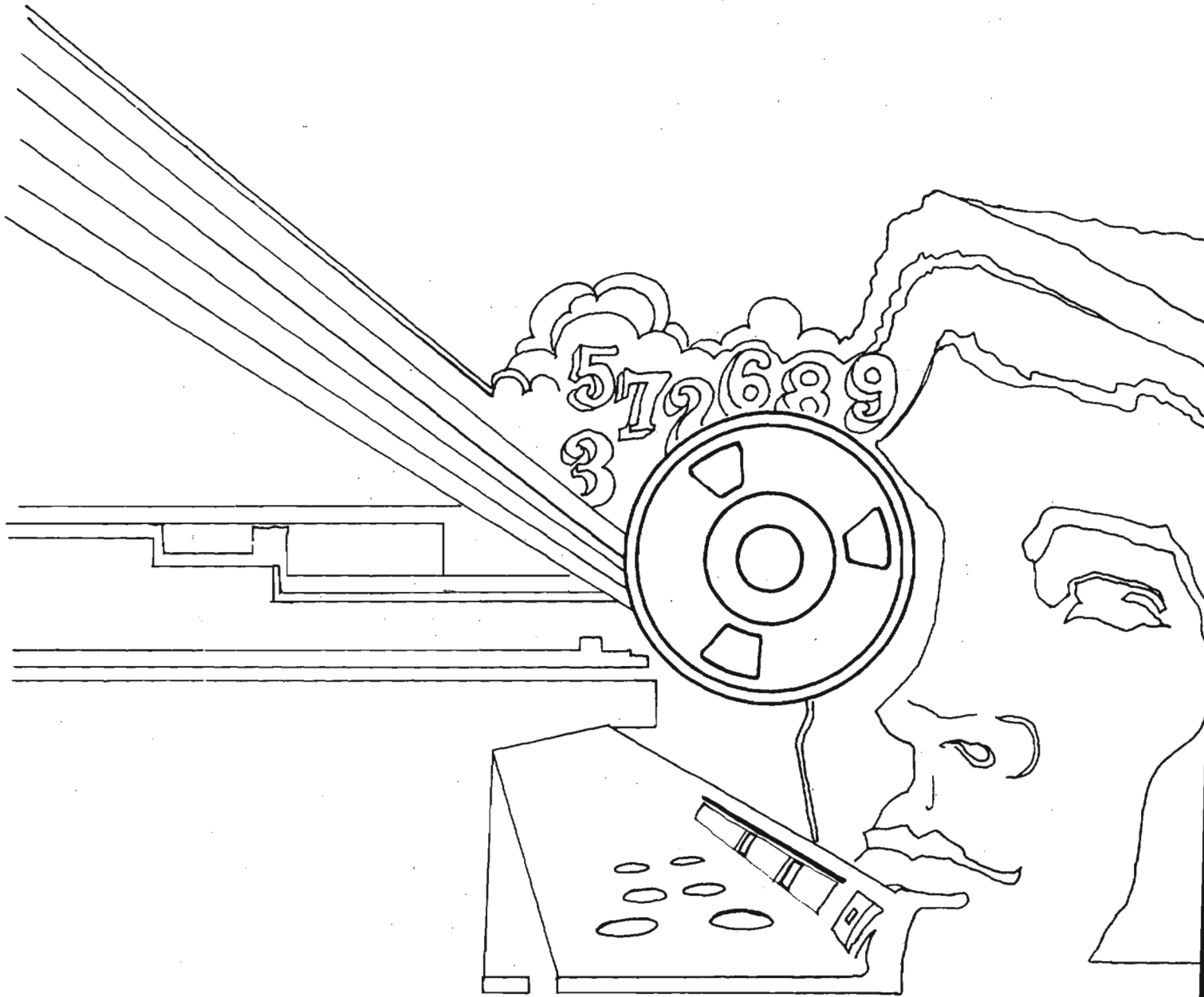

~~THIS DOCUMENT CONTAINS CODEWORD MATERIAL~~

~~SECRET~~

~~NOT RELEASABLE TO CONTRACTORS~~

**NATIONAL
SECURITY
ARCHIVE**

This document is from the holdings of:

The National Security Archive

Suite 701, Gelman Library, The George Washington University

2130 H Street, NW, Washington, D.C., 20037

Phone: 202/994-7000, Fax: 202/994-7005, nsarchiv@gwu.edu