

SECRET

COPY NO. \_\_\_\_\_

JOINT PHOTOGRAPHIC INTELLIGENCE REPORT

SOVIET GUIDED MISSILES  
7 NOVEMBER 1957 MOSCOW PARADE



ARMY



CIA



NAVY

**HTAUTOMAT FILE COPY**

PIC/R-1/58

OCTOBER 1958

WARNING  
THIS IS A RECORD COPY

THIS REPORT IS NOT TO BE LOANED OR  
DESTROYED UNDER ANY CIRCUMSTANCES.  
THE ORIGINAL MANUSCRIPT NEGATIVES  
HAVE BEEN DESTROYED.

Coordinated, Published, and Disseminated by  
CENTRAL INTELLIGENCE AGENCY  
PHOTOGRAPHIC INTELLIGENCE CENTER

Declass Review by NIMA / DoD

Approved For Release 2001/09/01 : CIA-RDP78T04751A000700010001-7

**W A R N I N G**

This material contains information affecting the National Defense of the United States within the meaning of the espionage laws, Title 18, USC, Secs. 793 and 794, the transmission or revelation of which in any manner to an unauthorized person is prohibited by law.

Approved For Release 2001/09/01 : CIA-RDP78T04751A000700010001-7

25X1A

Approved For Release 2001/09/01 : CIA-RDP78T04751A000700010001-7

Approved For Release 2001/09/01 : CIA-RDP78T04751A000700010001-7

**SECRET**

Approved For Release 2001/09/01 : CIA-RDP78T04751A000700010001-7

**SOVIET GUIDED MISSILES**

**7 November 1957 Moscow Parade**

**PIC/R-1/58**

**October 1958**

Approved For Release 2001/09/01 : CIA-RDP78T04751A000700010001-7

**SECRET**

SECRET

Approved For Release 2001/09/01 : CIA-RDP78T04751A000700010001-7

TABLE OF CONTENTS

	Page
I. Introduction . . . . .	5
II. Boosted Surface-to-Air Missile (SA-1B) . . . . .	5
III. 15 N. M. Ballistic Rocket . . . . .	10
IV. Ballistic Missile SS-1 . . . . .	12
V. 35 N. M. Ballistic Rocket . . . . .	14
VI. Ballistic Missile SS-3 . . . . .	16

SECRET

I. INTRODUCTION

This is a joint photographic intelligence report prepared by the Army, Navy, and CIA, under Army Chairmanship. It is intended to fulfill intelligence community requirements on missiles appearing in the 7 November 1957 parade in Moscow. It utilizes a series of 5 photographs and 11 drawings in presenting dimensional and configurational analyses of the 5 missiles displayed in the parade. Estimated range capabilities are relative to the strength of present United States missile propellants. Other available information on United States [redacted] missile systems has been utilized in the configurational analysis.

25X6

The quality of the photography ranges from good to poor, and the detail of the analyses varies accordingly. Mensural data for each missile presented on the drawings may have the following ranges of error:

<u>Missile</u>	<u>Range of Error</u>
Boosted Surface-to-Air Missile (SA-1B)	[redacted]
15 N. M. Ballistic Rocket	
Ballistic Missile SS-1	
35 N. M. Ballistic Rocket	
Ballistic Missile SS-3	

25X1B

II. BOOSTED SURFACE-TO-AIR MISSILE (SA-1B)

A. General

The missile is a boosted vehicle, with a probable solid propellant booster engine and a probable liquid propellant sustainer motor. The over-all length of 37.4 feet places it approximately midway between the lengths of the [redacted] feet.

25X1D

B. Configurational Analysis

Analysis of the photography indicates a missile similar in operation to the [redacted]. The missile consists of two major systems; the propulsion system and the guidance and control system.

25X1D

SECRET

Approved For Release 2001/09/01 : CIA-RDP78T04751A000700010001-7



#### 1. Propulsion System

The propulsion system of the missile body appears to utilize a solid propellant booster rocket engine and a liquid propellant missile rocket sustainer motor.

The external configuration of the booster is very simple, comparable in appearance to the [REDACTED] booster configuration. The absence of any propellant loading ports indicates the booster is a probable solid propellant rocket engine.

25X1D

The missile utilizes a probable liquid propellant rocket sustainer motor which is located aft of the four steering fins. Four objects are positioned on the thrust joint. Just aft of the steering fins is the probable actuator and actuator arm assembly which joins with the booster. Upon booster burn out, the aerodynamic drag on the booster causes booster separation, pulling the actuator arm, initiating action by the actuator, thereby firing the missile sustainer motor. There are two possible propellant loading ports located on the missile fuselage between the stabilizer fins. The presence of these ports and the actuator assembly support the theory of the missile propulsion system being a liquid propellant rocket sustainer motor.

- 6 -

Approved For Release 2001/09/01 : CIA-RDP78T04751A000700010001-7

SECRET

SECRET

Approved For Release 2001/09/01 : CIA-RDP78T04751A000700010001-7

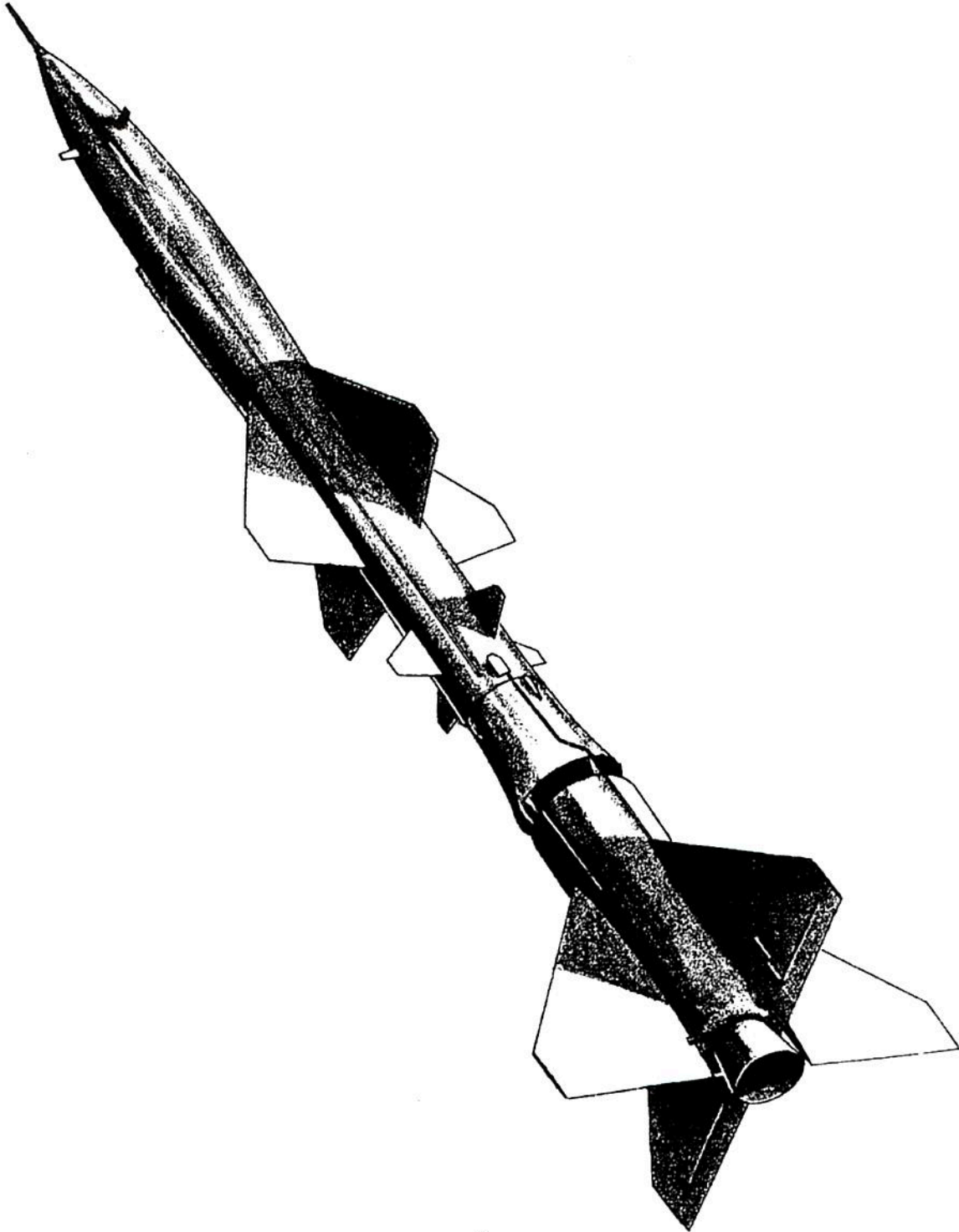

- 7 -

Approved For Release 2001/09/01 : CIA-RDP78T04751A000700010001-7

SECRET



SECRET

Approved For Release 2001/09/01 : CIA-RDP78T04751A000700010001-7

## 2. Guidance and Control System

The guidance and control system of the missile consists of a pitot tube, four probable antennae, four stabilizer fins, four steering fins, and probably two booster fin ailerons.

The pitot tube projecting from the nose of the missile could provide the missile computer with stagnation pressure information. The stagnation pressure includes both static (altitude) and dynamic (velocity) pressure. This information could influence the order-limiting (strength of commands) sent from the missile computer to the steering mechanism.

25X1D

The four probable antennae are placed approximately at the same position on the Soviet missile as the four antennae on the [REDACTED] and could function in a command guidance system similar to that utilized for the [REDACTED]. The operational Soviet B-200 guidance system is a command guidance-type system.

25X1D

The four stabilizer fins provide the lift which assists in attitude stabilization during the flight of the missile.

Aft of the stabilizer fins are the four steering fins. These fins are probably connected to a missile guidance package by cables which could be placed in the probable cable channels. These cable channels could be provided by the elongated blisters on the surface of the missile skin, and they extend from the probable location of a guidance package to the steering fin mechanism. It is interesting to note that the Soviets have not employed the canard configuration for control as is employed by the [REDACTED].

25X1D

The probable two booster fin ailerons could be used for roll stabilization, or missile orientation.

## C. Conclusions

Configurational analysis of the Boosted Surface-to-Air Missile (SA-1B) indicates the following characteristics:

1. Boosted surface-to-air guided missile
2. Probable solid propellant booster rocket engine
3. Probable liquid propellant missile sustainer motor
4. Probable command guidance system
5. Probable capabilities similar to the [REDACTED]

25X1D

SECRET

SECRET

Approved For Release 2001/09/01 : CIA-RDP78T04751A000700010001-7

*Guideline*

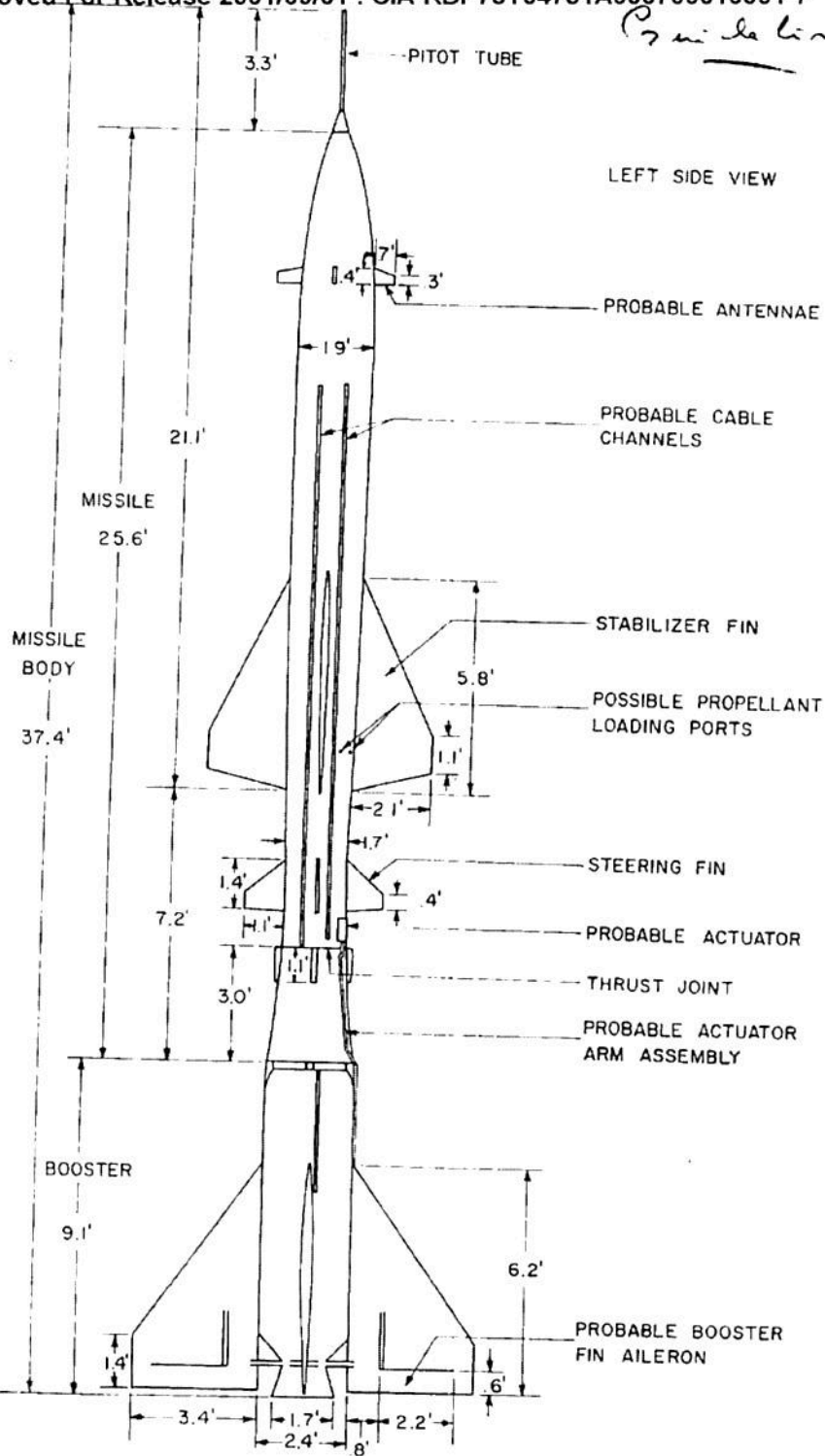

SECRET

### III. 15 N.M. BALLISTIC ROCKET

#### A. General

The Soviet "Honest John Type" ballistic missile is a probable solid propellant boosted vehicle with an estimated range capability of 15 nautical miles.

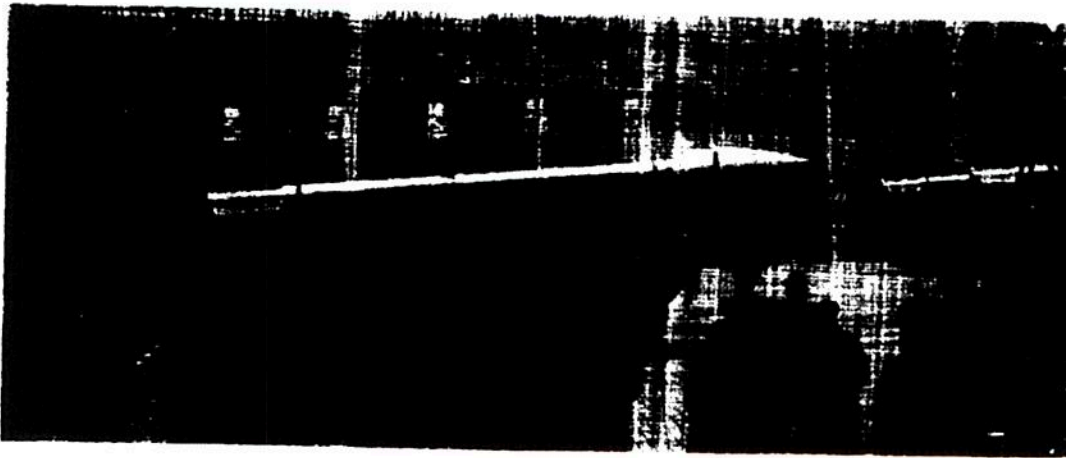

#### B. Configurational Analysis

The boosted vehicle consists of the missile and its booster which have been arbitrarily divided into four sections: the warhead, the probable solid propellant missile sustainer engine, the probable solid propellant booster engine, and the booster stabilizer fins.

#### 2. Probable Solid Propellant Missile Sustainer Engine

The missile sustainer engine is located in the aft end of the second stage. The uniformity of diameter and the simplicity of the missile skin construction indicates that the missile probably utilizes a solid propellant sustainer engine.

#### 3. Probable Solid Propellant Booster Engine

The booster fuselage has the same characteristics of construction as the missile fuselage, and therefore, it utilizes a probable solid propellant booster engine.

SECRET

SECRET

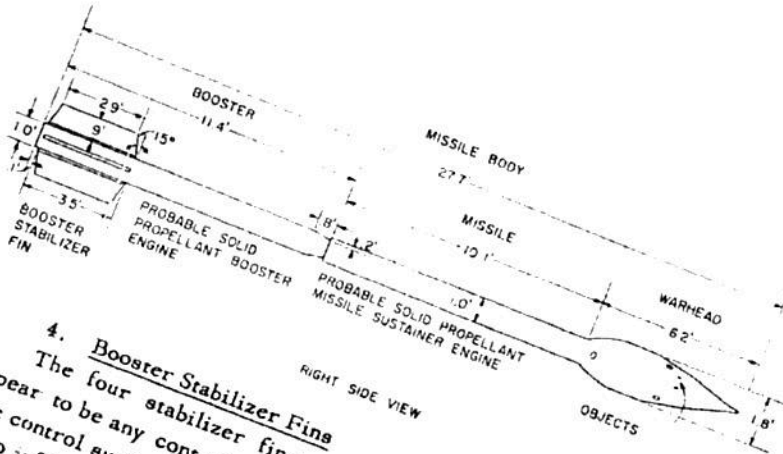

4. Booster Stabilizer Fins  
 The four stabilizer fins appear to be immovable and there do not appear to be any control ailerons. With this apparent absence of any movable control surfaces, there seems to be no capability for any guidance system to influence missile attitude during flight trajectory.
- C. Conclusions  
 Configurational analysis of the 15 N.M. Ballistic Rocket indicates the following characteristics.
1. Boosted surface-to-surface ballistic missile
  2. [REDACTED]
  3. Probable free flight trajectory
  4. Probable solid propellant rocket engines

SECRET

25X9

SECRET

Approved For Release 2001/09/01 : CIA-RDP78T04751A000700010001-7

#### IV. BALLISTIC MISSILE SS-1

##### A. General

The missile is a non-boosted vehicle with an estimated range of 75-100 nautical miles. Due to the poor quality of the photography, the desired detail in analysis could not be obtained.

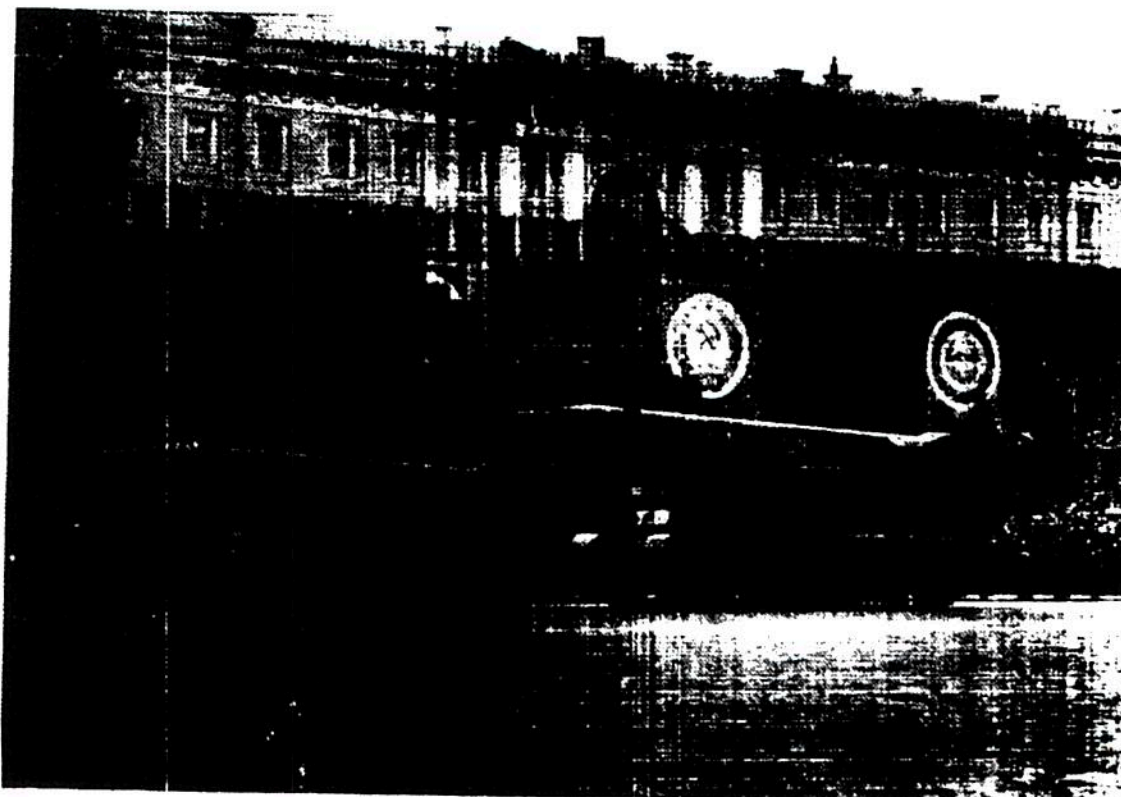

25X2

The missile control surfaces could not be examined in detail, but it is believed that control of the missile is probably accomplished by air vanes and jet vanes. The guidance of the missile is possibly inertial, for no antennae could be identified.

There are two cylindrical tanks carried on the side of the prime mover which could be pre-metered propellant containers. This indicates that the missile has a possible liquid propulsion system rather than a solid propulsion system.

- 12 -

Approved For Release 2001/09/01 : CIA-RDP78T04751A000700010001-7

SECRET

SECRET

Approved For Release 2001/09/01 : CIA-RDP78T04751A000700010001-7

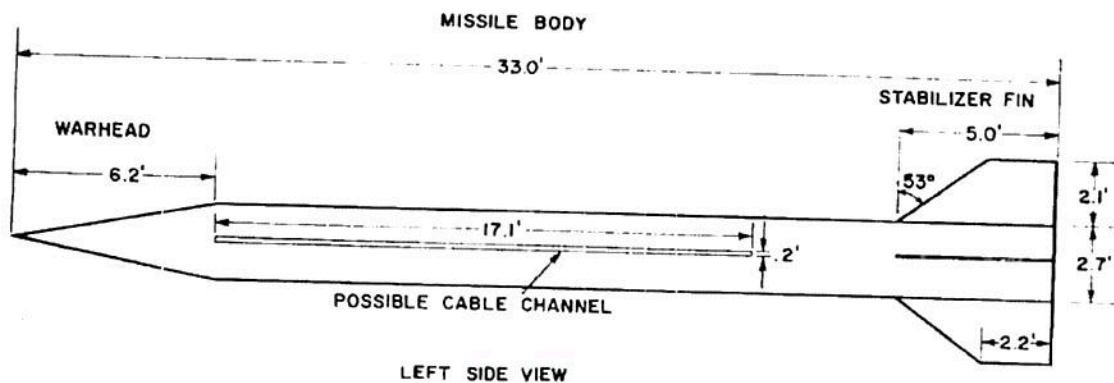
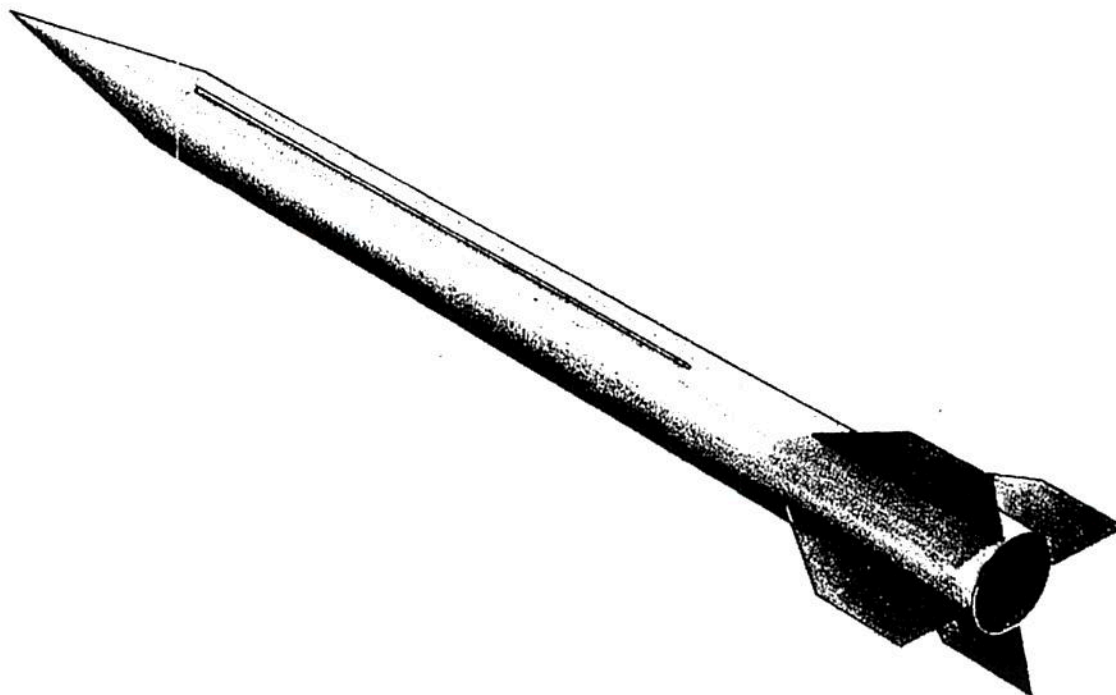

25X2

SECRET

Approved For Release 2001/09/01 : CIA-RDP78T04751A000700010001-7

V. 35 N. M. BALLISTIC ROCKET

A. General

The missile is a probable solid propellant vehicle with an estimated range capability of 35 nautical miles.

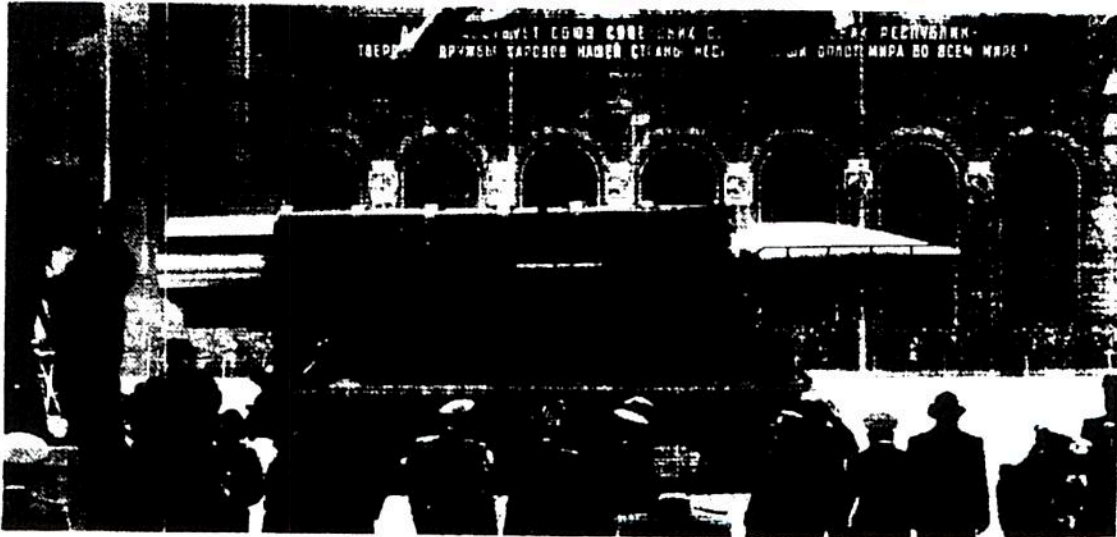

B. Configurational Analysis

The missile is similar in configuration to the Soviet 15 N. M. Ballistic Rocket, but it is approximately twice as large in diameter, seven feet longer, and has a greater payload capability. This warhead also has objects on its surface similar to those found on the 15 N. M. Ballistic Rocket.

The missile is partially encased by a ribbed metal casing that may incorporate a heating element to prevent cold-weather damage to the solid propellant of the engine. The main exhaust exits through a cluster of seven apertures at the rear, but additional canted nozzles are probably provided to impart slow spin for accuracy. Because of the metal casing it could not be determined from the photography whether the missile is boosted or non-boosted. The visible control surfaces consist of six apparently immovable stabilizer fins with no apparent ailerons.

C. Conclusions

The 35 N. M. Ballistic Rocket appears to be similar to the "Honest John Type" missile but probably has a larger warhead and a greater range capability.

- 14 -

Approved For Release 2001/09/01 : CIA-RDP78T04751A000700010001-7

SECRET

SECRET

Approved For Release 2001/09/01 : CIA-RDP78T04751A000700010001-7

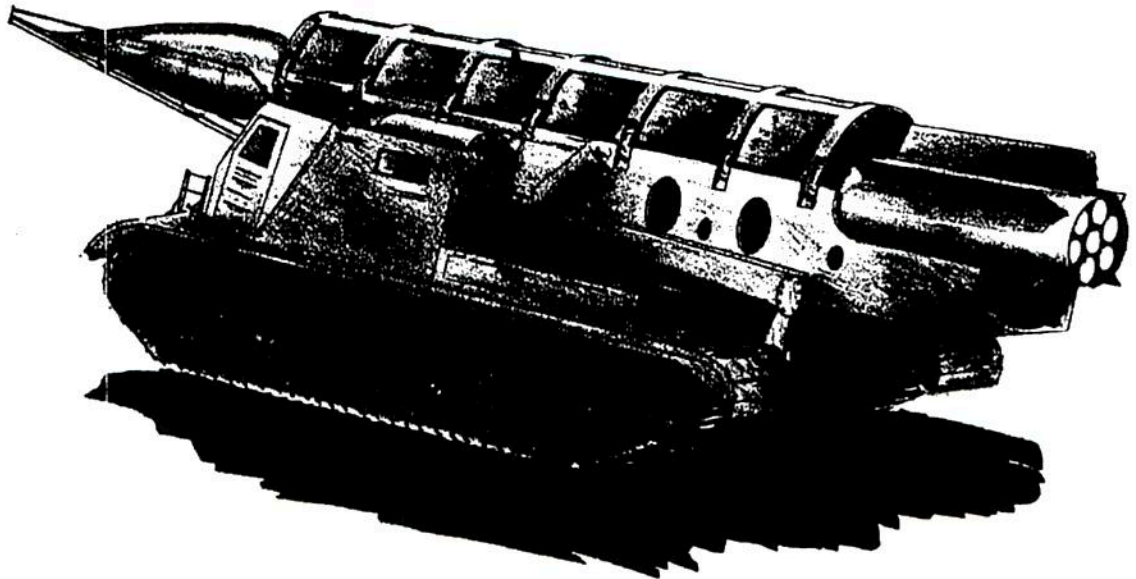
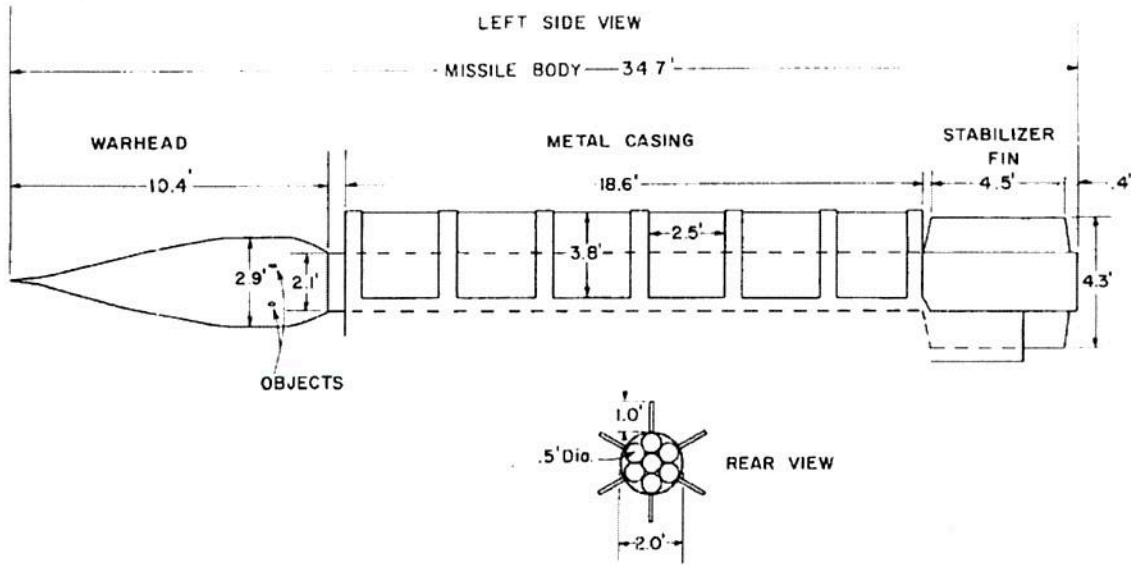

SECRET



SECRET

Approved For Release 2001/09/01 : CIA-RDP78T04751A000700010001-7

## VI. BALLISTIC MISSILE SS-3

### A. General

The "V-2 Type" Soviet missile is a probable liquid propellant, single-stage missile, with an estimated range capability of 350 nautical miles.



### B. Configurational Analysis

This, the largest missile shown in the parade, appears to be a final phase in the development of the German "V-2 Series" and has a [REDACTED]

[REDACTED] A probable propellant loading port (not shown on graphic) is located near the forward end of the missile indicating the probable utilization of a liquid propulsion system.

The guidance system is undetermined from the present photography, but it is thought to be a radio-inertial type guidance system. The control surfaces of the missile consist of four external vanes located on the missile stabilizer fins, and four internal probable carbon vanes located within the exhaust channel. The four internal vanes appear to be mechanically connected to the four external vanes, and they probably operate in conjunction with each other to influence missile attitude during flight trajectory.

- 16 -

Approved For Release 2001/09/01 : CIA-RDP78T04751A000700010001-7

SECRET

25X9

25X9

SECRET

Approved For Release 2001/09/01 : CIA-RDP78T04751A000700010001-7

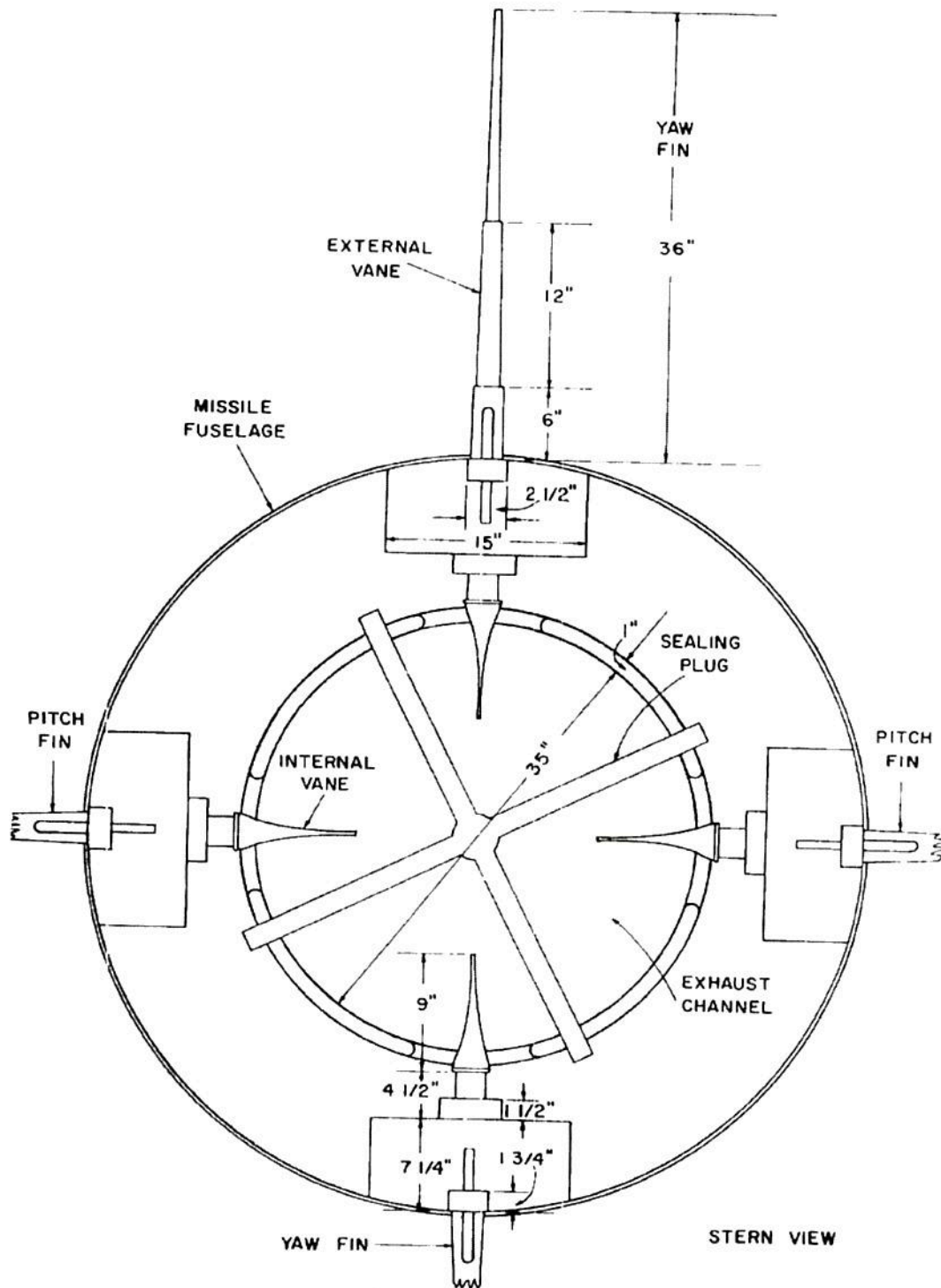

- 17 -

Approved For Release 2001/09/01 : CIA-RDP78T04751A000700010001-7

SECRET

C. Conclusions

The SS-3 missile has the following characteristics:

1. Probable liquid propellant sustainer motor
2. Possible radio-inertial guidance system
3. Internal and external vanes control system



25X9

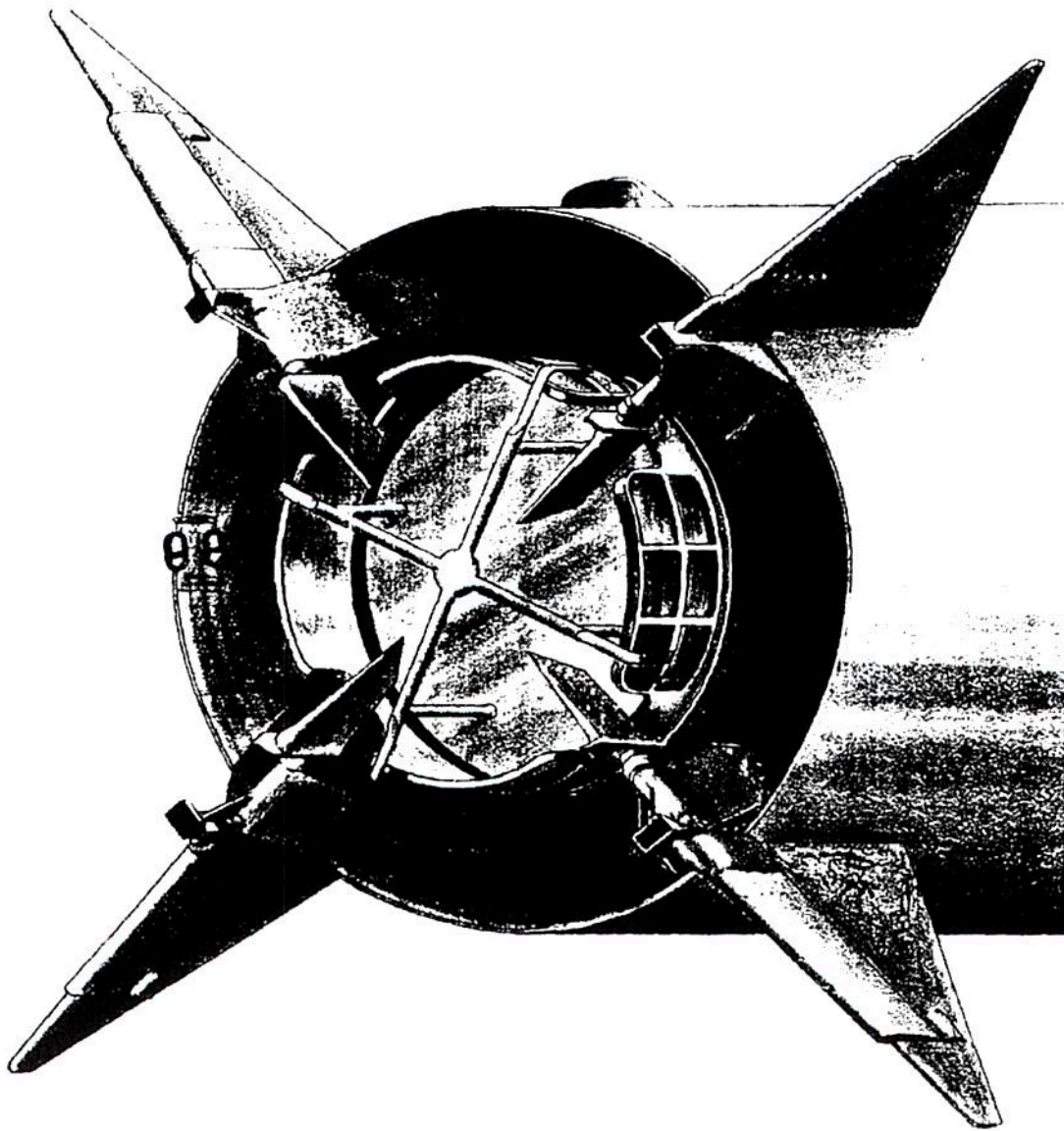

SECRET

Approved For Release 2001/09/01 : CIA-RDP78T04751A000700010001-7

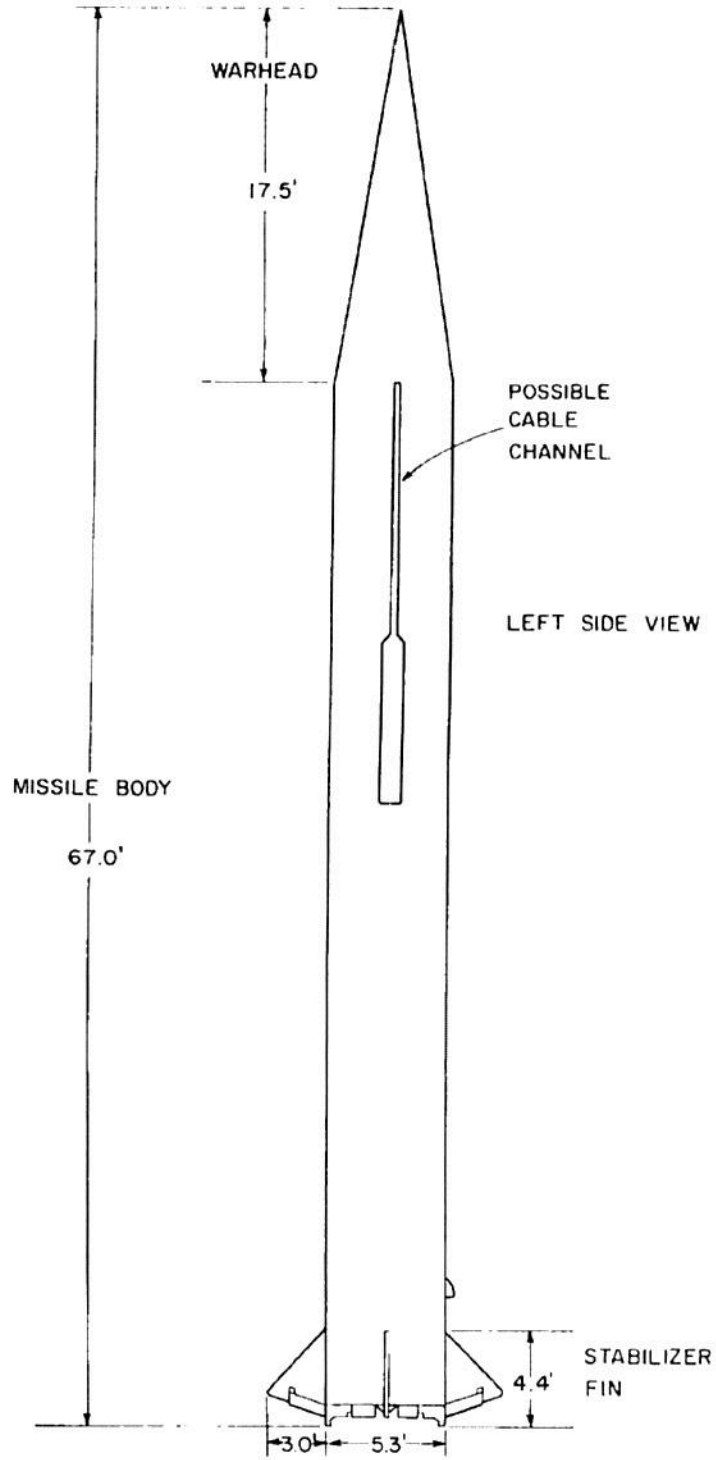

Approved For Release 2001/09/01 : CIA-RDP78T04751A000700010001-7

SECRET

PHOTO DATA:

25X1C

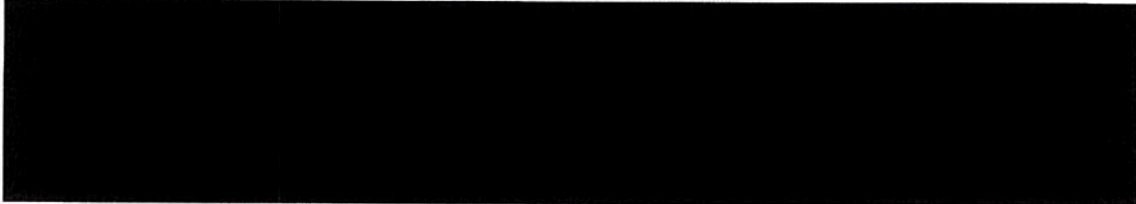

REFERENCE DATA:

- AFM 200-14, Intelligence Collection Guidance Manual. (C)
- AAA & GM School (Notes), Ft. Bliss, Texas. (C)
- AFM 52-31, Guided Missile Fundamentals. (U)
- Summary of Significant Soviet Weapons and Equipment, Project NR:  
A-1046, DA-ACSI. (S)

SECRET

Approved For Release 2001/09/01 : CIA-RDP78T04751A000700010001-7

Approved For Release 2001/09/01 : CIA-RDP78T04751A000700010001-7

SECRET

**NATIONAL  
SECURITY  
ARCHIVE**

This document is from the holdings of:

The National Security Archive

Suite 701, Gelman Library, The George Washington University

2130 H Street, NW, Washington, D.C., 20037

Phone: 202/994-7000, Fax: 202/994-7005, [nsarchiv@gwu.edu](mailto:nsarchiv@gwu.edu)





**NATIONAL  
SECURITY  
ARCHIVE**

This document is from the holdings of:

The National Security Archive

Suite 701, Gelman Library, The George Washington University

2130 H Street, NW, Washington, D.C., 20037

Phone: 202/994-7000, Fax: 202/994-7005, [nsarchiv@gwu.edu](mailto:nsarchiv@gwu.edu)